



Industrial Wear Modes and Failure Analysis

The webinar will begin in less than 10 minutes.

David Turner, CLS, OMA-I, CLGS



Industrial Wear Modes and Failure Analysis

The webinar will begin in less than 5 minutes.

David Turner, CLS, OMA-I, CLGS



Industrial Wear Modes and Failure Analysis

David Turner, CLS, OMA-I, CLGS

David Turner

- CITGO Sr. Technical Services Representative
- BS, Chemical Engineering
- 39+ Years Experience in Lubricants
- STLE Certified
 - Certified Lubrication Specialist
 - Oil Monitoring Analyst I
- NLGI Certified
 - Certified Lubricating Grease Specialist
- Active in STLE, NLGI, and ASTM



Agenda

- Wear Modes
- Failure Analysis
 - Rolling Element Bearings
 - Gears



Wear Modes

Asperities

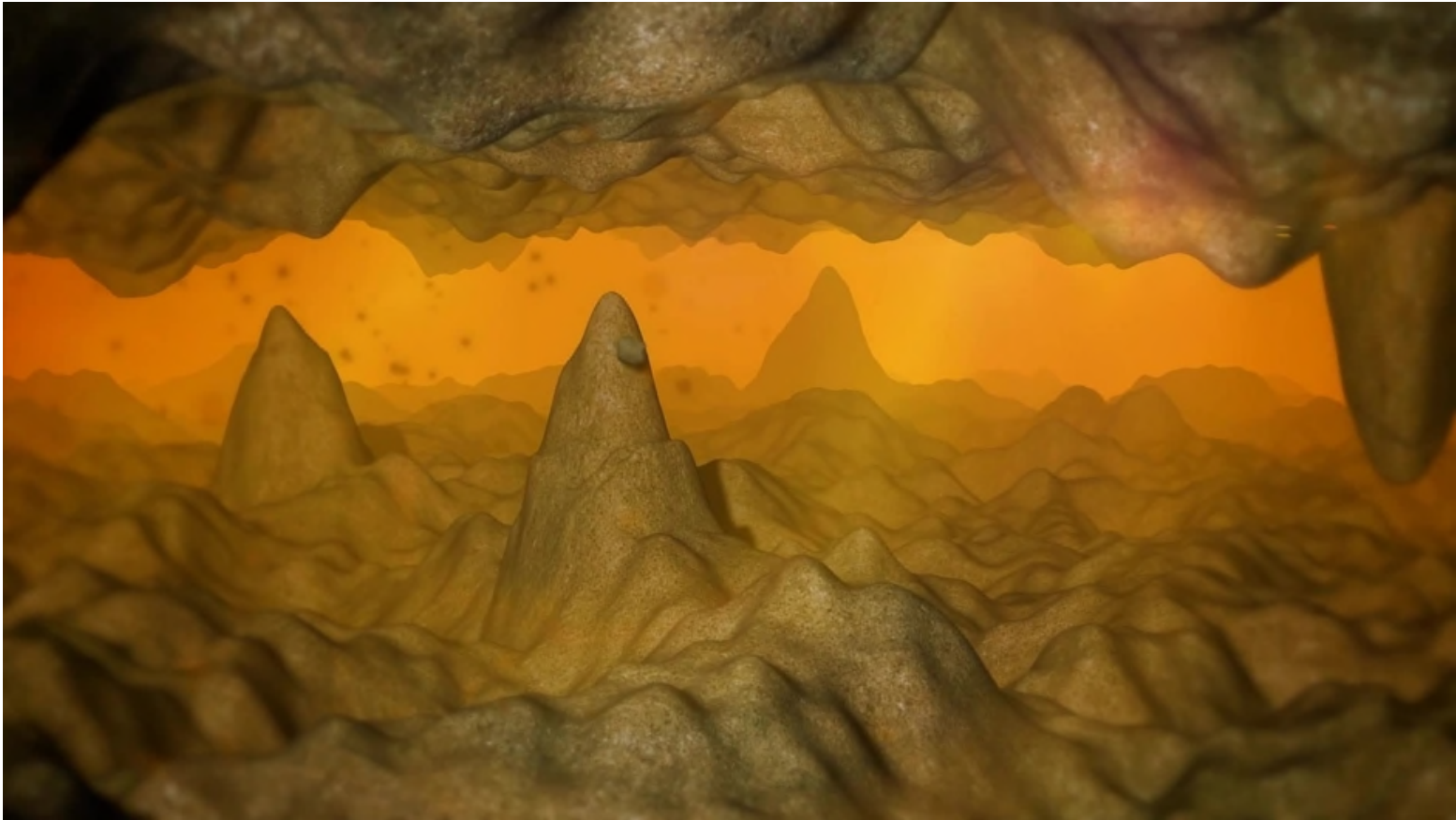

Wear

- Wear – Damage to a solid surface, generally involving progressive loss of material, due to relative motion between that surface and a contacting substance or substances.

Abrasive

Adhesive

Fatigue

Erosive

Corrosive

Cavitation

Polishing

Fretting

Electrical
Discharge

Abrasive Wear

Abrasive wear – Wear due to hard particles or hard protuberances forced against and moving along a solid surface. These hard particles might be commercial abrasives like silicon carbide and aluminum oxide, or naturally occurring contaminants like dust particles and sand [crystalline silica (quartz)]. If the abrasive particles are allowed to roll, rolling abrasion or three-body abrasion occurs.

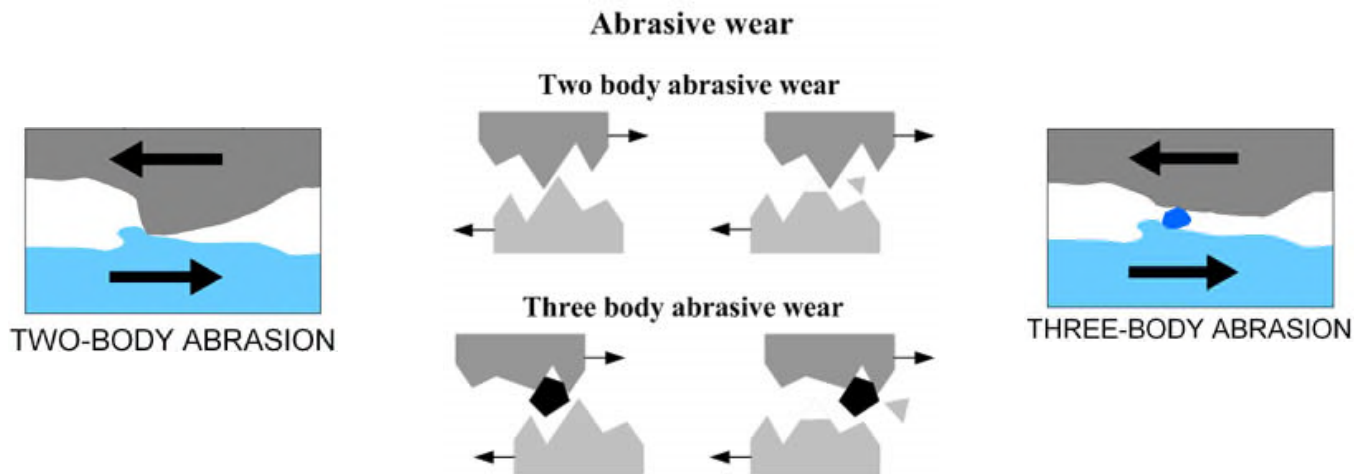

Abrasive Wear

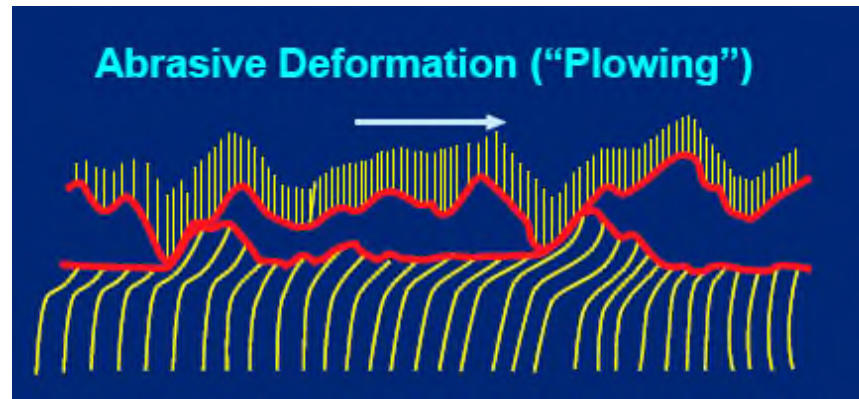
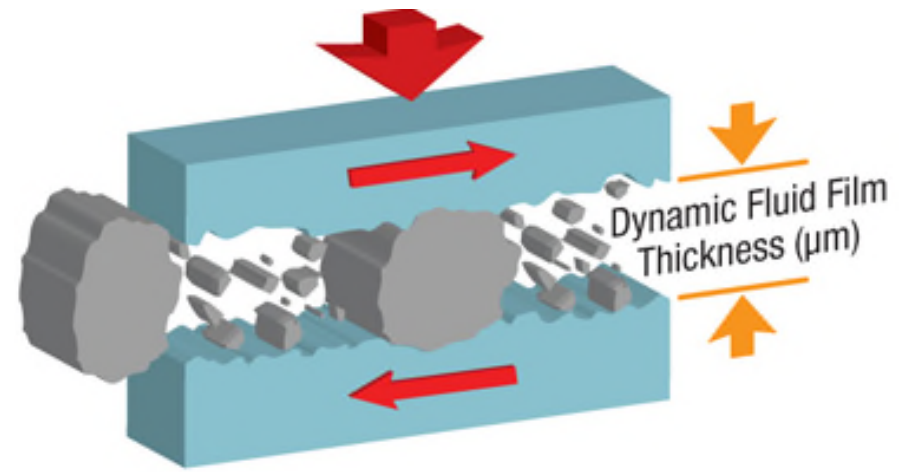
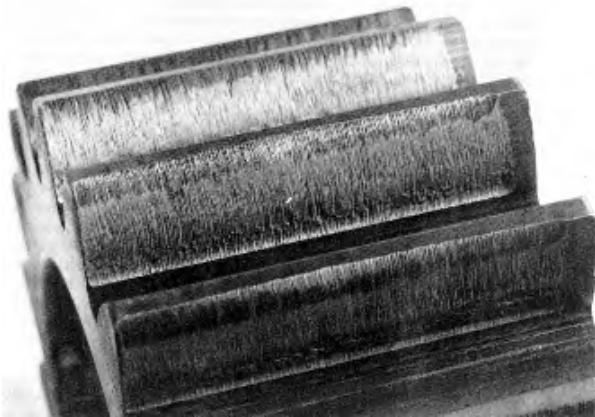

Adhesive Wear

Adhesive wear – Wear due to localized bonding between contacting solid surfaces leading to material transfer between the two surfaces or loss from either surface. Adhesive wear is not as prevalent as abrasive wear and is induced when like materials slide against each other with no lubrication. This type of wear involves the formation of local cold welds between surfaces contacting under a load and tangential shearing or plowing of the junctions. Material can be transferred from one surface to the other during this process.

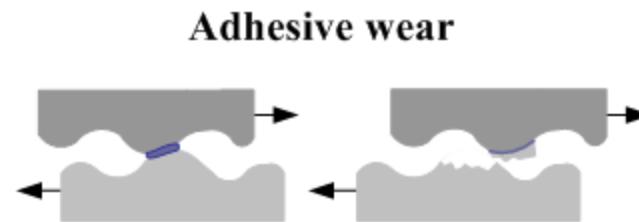
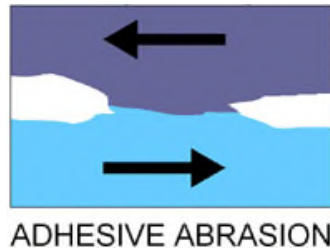

Adhesive Wear

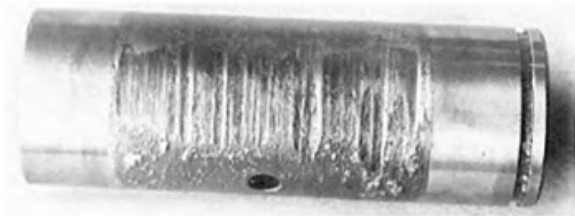

scuffing
scoring
galling

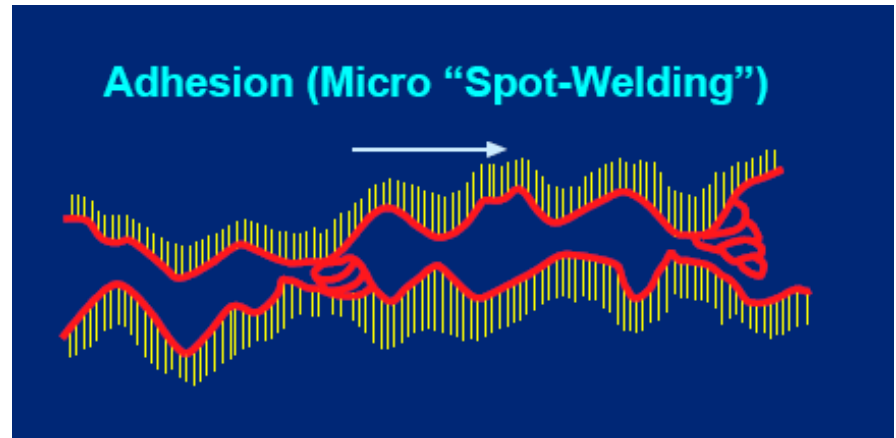

Fatigue Wear

Fatigue wear – Wear of a solid surface caused by fracture arising from material fatigue.

This is the normal wear mode.

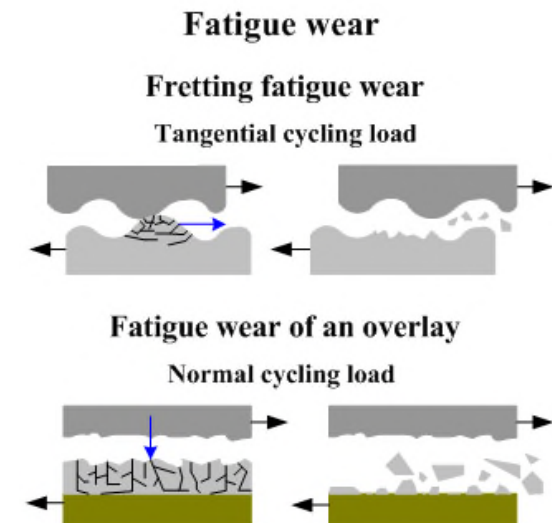
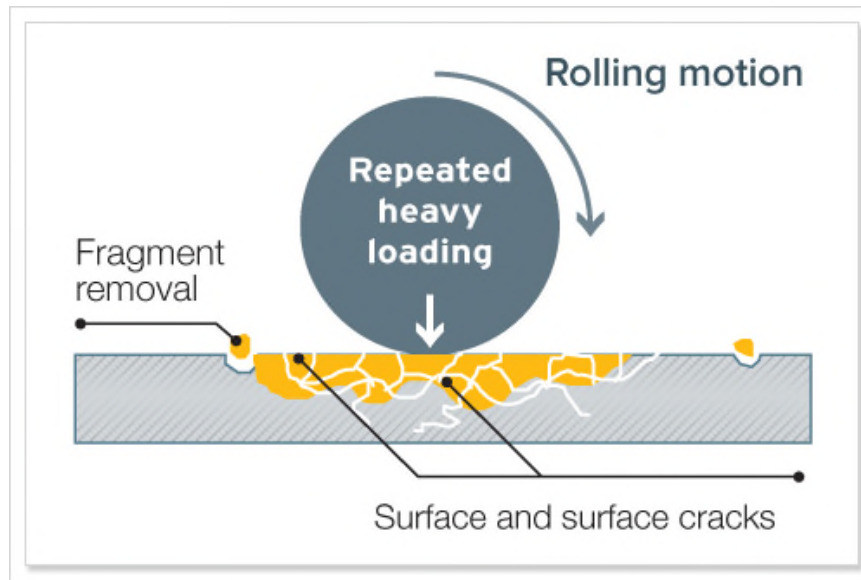

Fatigue Wear



fretting
micro-pitting
spalling

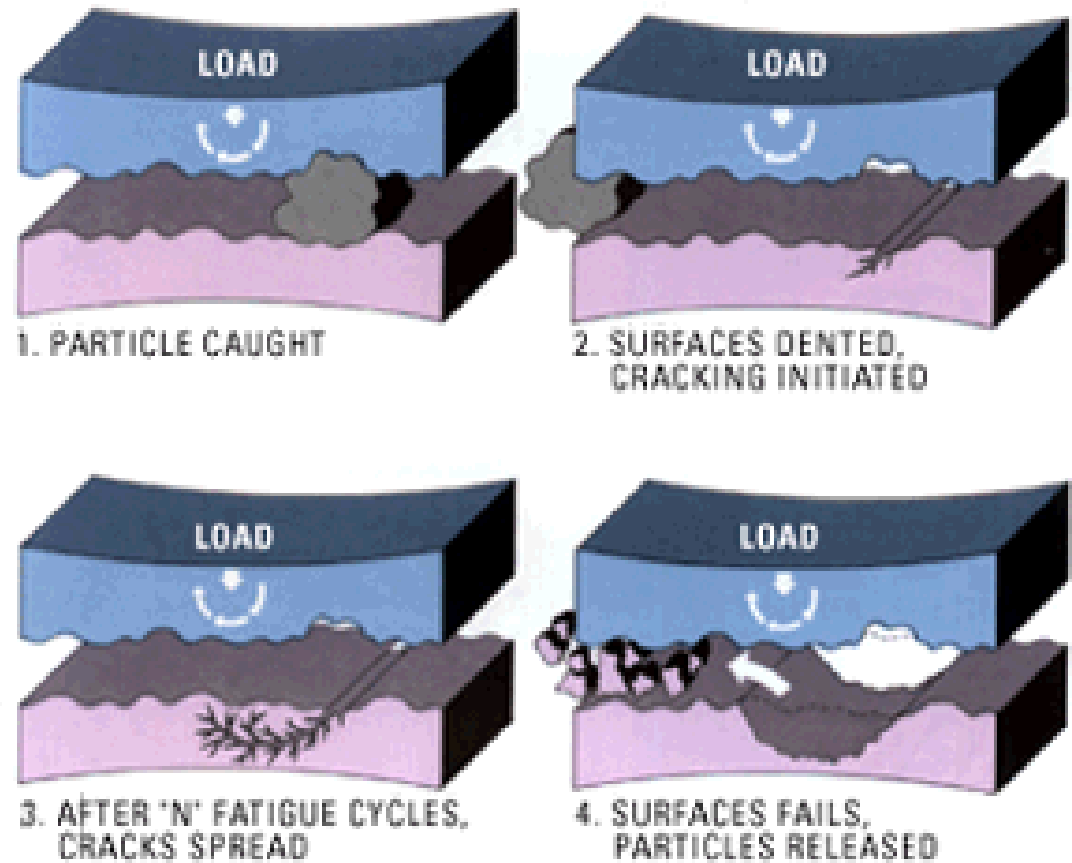

Erosive Wear

Erosive wear – Progressive loss of original material from a solid surface due to mechanical interaction between that surface and a fluid, multi-component fluid, or impinging liquid or solid particles.

Erosion - Damage caused by particulate in gases or liquids striking a surface.

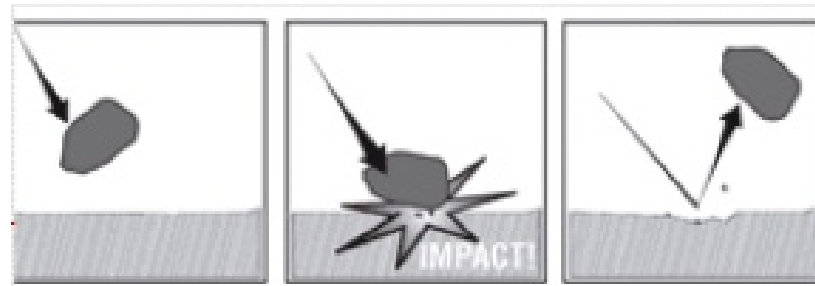

Erosive Wear

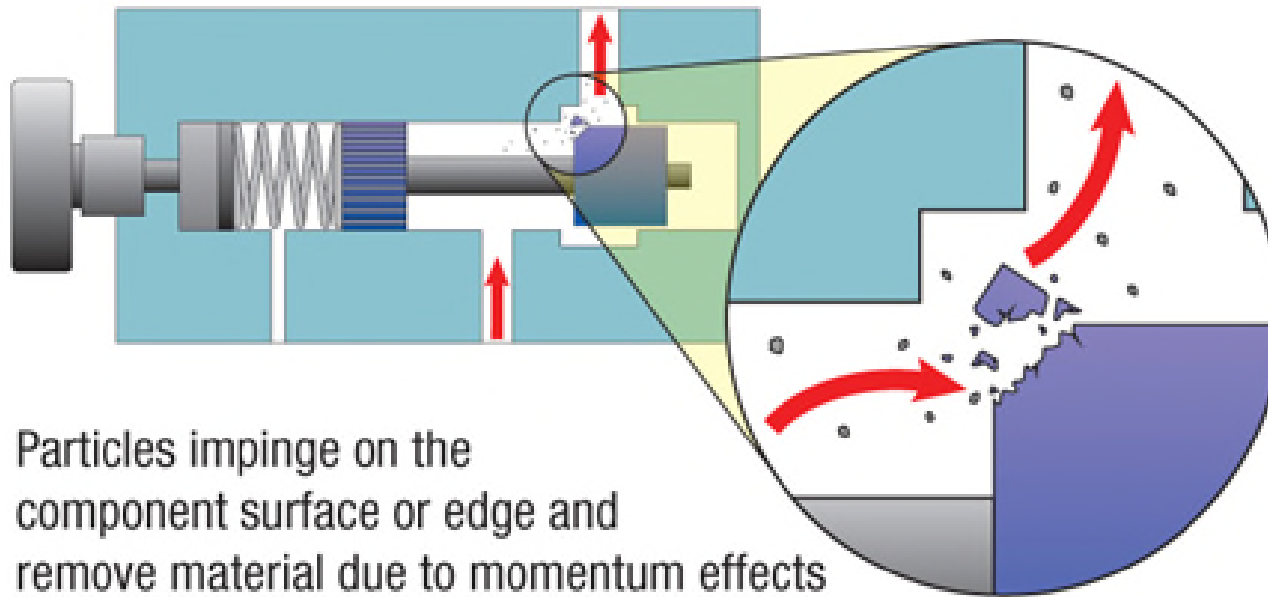

Particles impinge on the component surface or edge and remove material due to momentum effects

Corrosive Wear

Corrosive wear – Wear in which chemical or electrochemical reaction with the environment is significant.

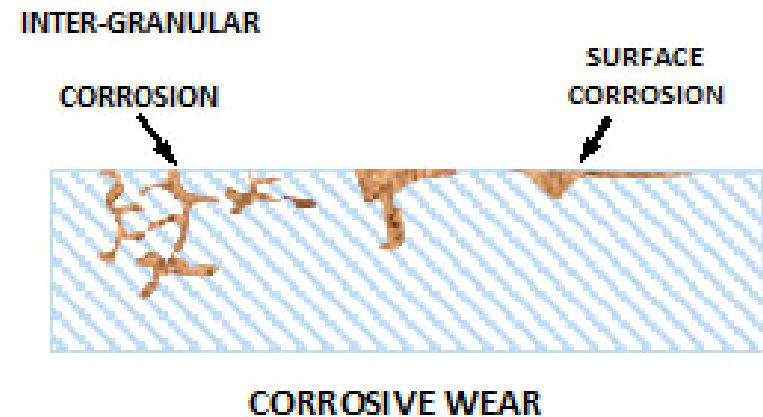
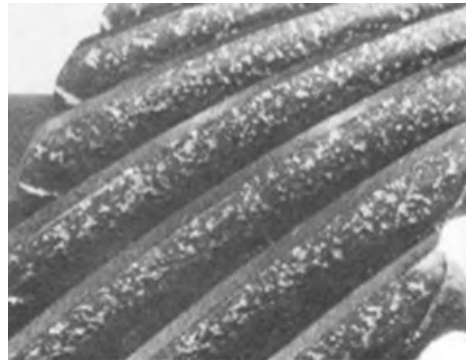

Corrosive Wear



Corrosion debris and irregularities lead to abrasive and adhesive wear!

Cavitation Wear

Cavitation wear – A special form of erosion in which vapor bubbles in the fluid form in low-pressure regions and are then collapsed (imploded) in the higher-pressure regions of the oil system. The implosion can be powerful enough to create holes or pits, even in hardened metal, if the implosion occurs at the metal surface. This type of wear is most common in hydraulic pumps, especially those which have restricted suction inlets or are operating at high elevations.

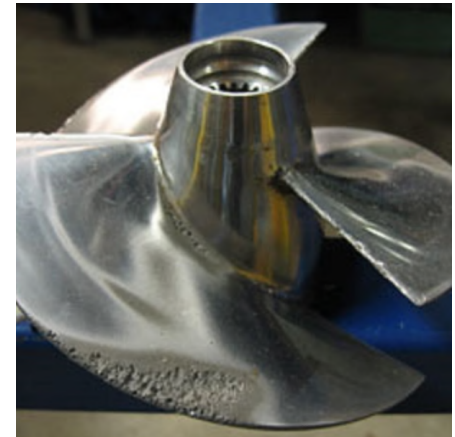

Cavitation

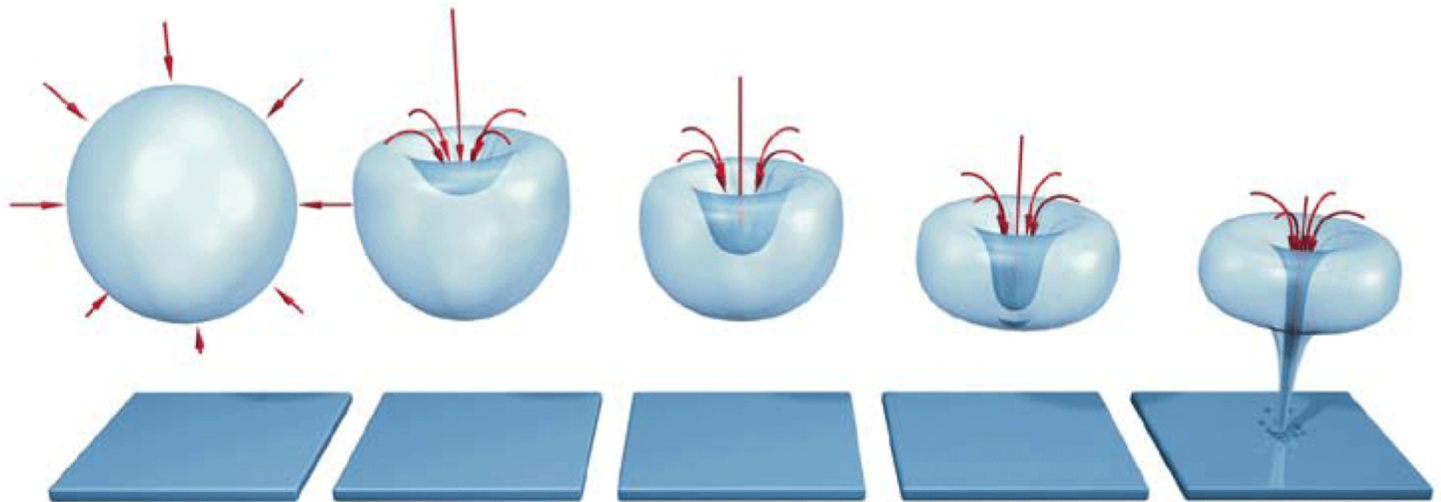

Jet pressure can reach
2,000,000 psi



Polishing Wear

Polishing wear – The removal of surface material by very fine hard particles in the lubricant, producing a brightly polished surface.

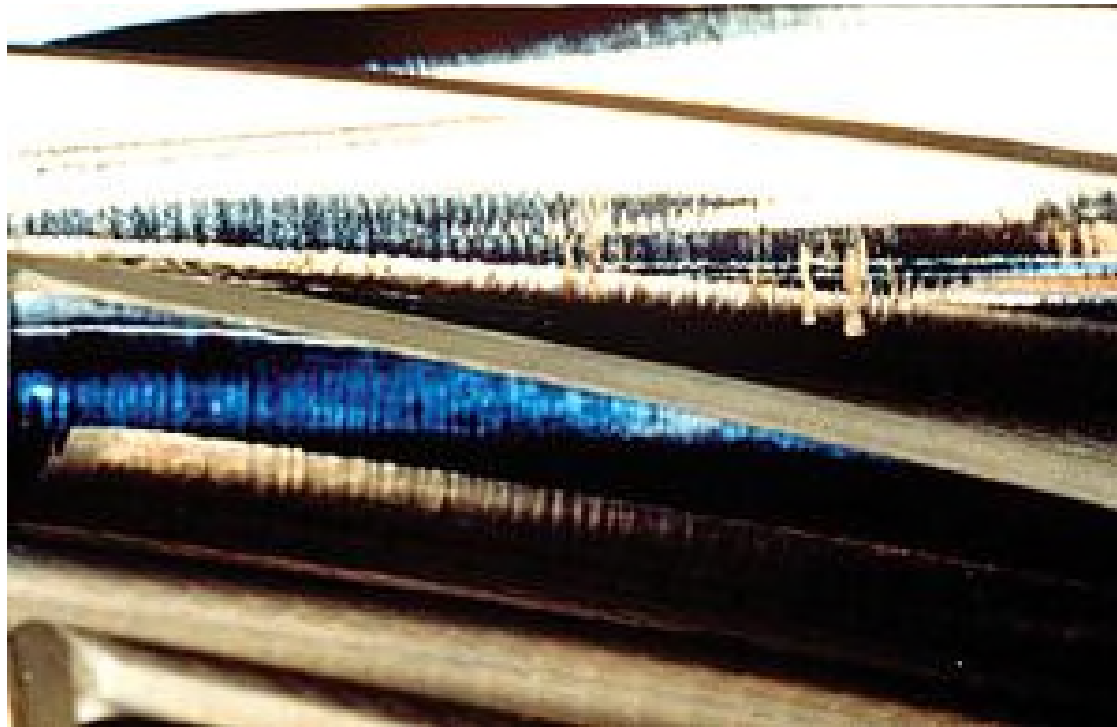

Polishing Wear

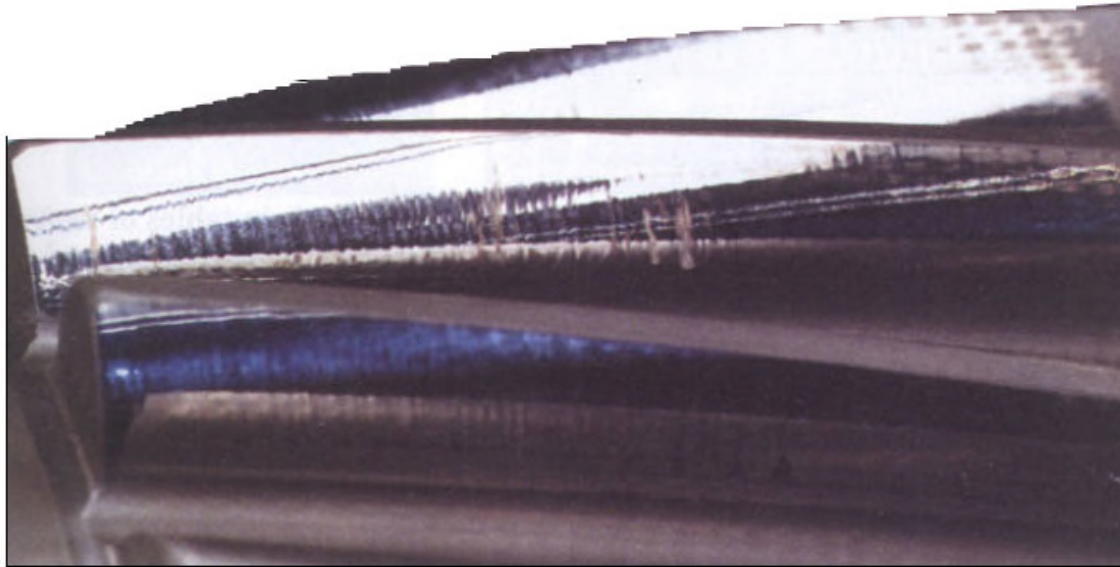

Figure 7 — Polishing type wear.

Polishing wear is characterized by very shiny, very smooth, mirror like metal surfaces. Fine abrasives wear away the surface films as they form and reform.

Fretting Wear

Fretting wear – Wear arising as a result of fretting [where fretting, in tribology, involves a small amplitude oscillatory motion, usually tangential, between two solid surfaces in contact]. Small wear particles are formed through the mechanism of adhesive wear.

Fretting Wear

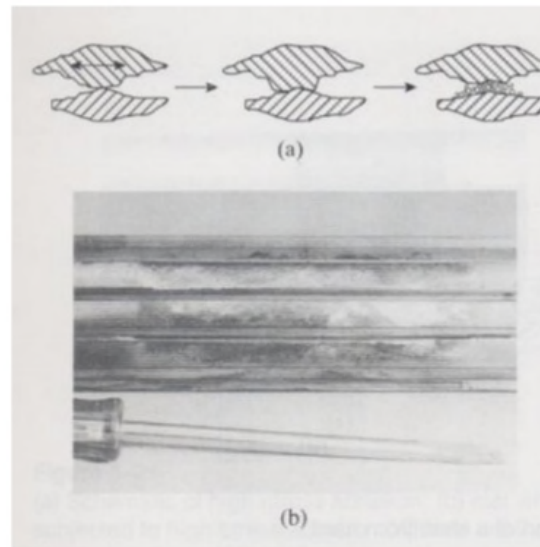

Fretting wear of splined shaft- small oscillatory motion abrades surface - looks like rust - surface looks pitted.

Fretting Wear



Fretting wear can be caused by low amplitude oscillation or vibration.

Electrical Discharge Wear

Electrical discharge wear – The removal of metal by high amperage electrical discharge or spark between two surfaces. It is often characterized by fluting.



Electrical Discharge Wear

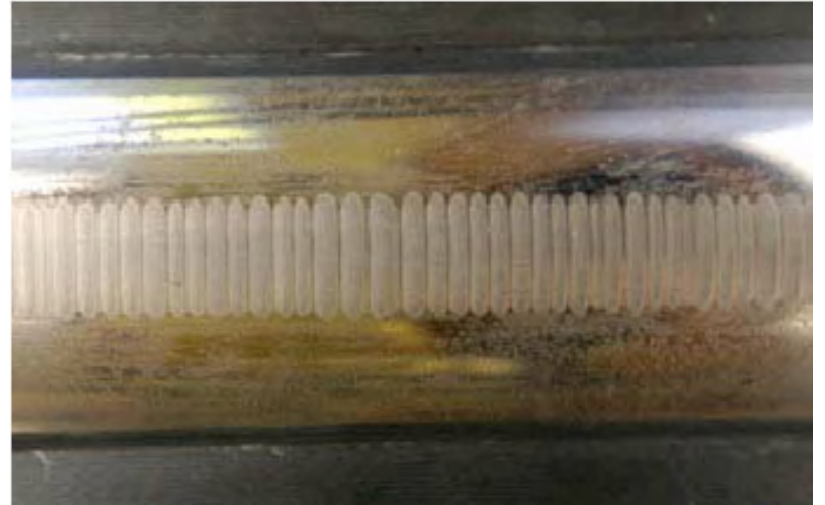
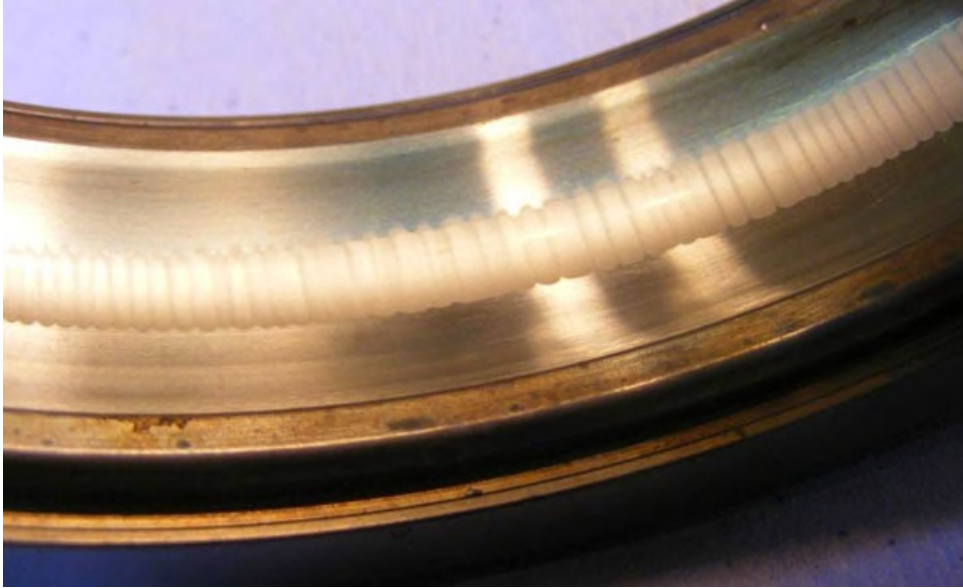

Electrical discharge wear can be prevented by proper motor grounding and proper grounding when welding.

Failure Analysis



Rolling Element Bearings

- Fretting Corrosion
 - Inadequate Lubrication
 - Contamination
 - Radial Preload
 - Out of Round
 - Axial Preload
 - Misalignment
 - Improper Lubrication
 - Corrosion
 - Brinelling
 - False Brinelling
 - Electrical Discharge
 - Ring Fractures
 - Overheating
 - Cage Damage
-

Fretting Corrosion

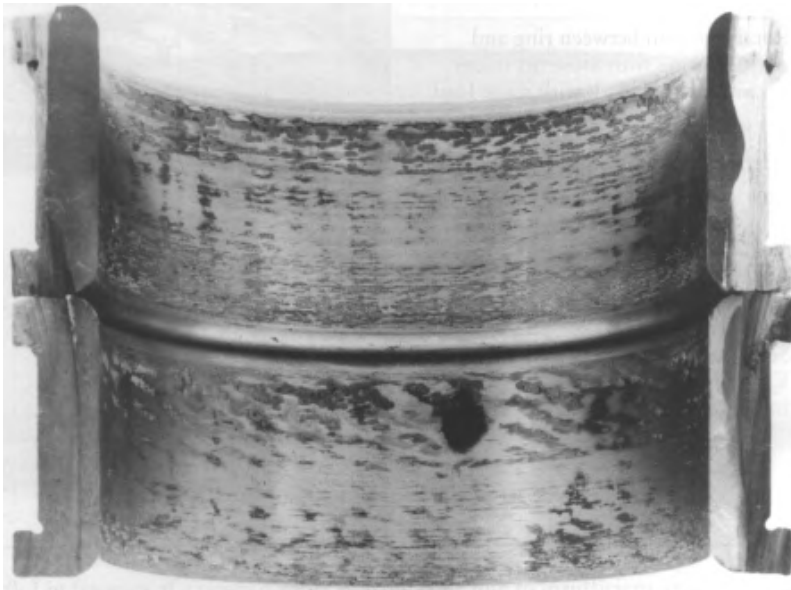



Fretting Corrosion

Symptoms:

- Brownish-black spots on the seats
- Wear at fitting surfaces
- Fatigue fracture possible in the case of rotating parts (usually the shaft)
- Disturbance of floating bearing function possible in the case of stationary parts (usually the housing)

Causes:

- Micro-motion between fitted parts where fits are too loose in relation to the acting forces, but no creeping of rings
- Form disturbance of fitting surfaces
- Shaft deflection, housing deformation
- Incorrect fit selection and surface finishes for the application

Possible remedies:

- Provide the correct fit and surface finish for each bearing ring
- Use fit selections that provide the best support of the bearing
- Make shaft and housing designs more rigid
- Surface coat bearing seats

Inadequate Lubrication

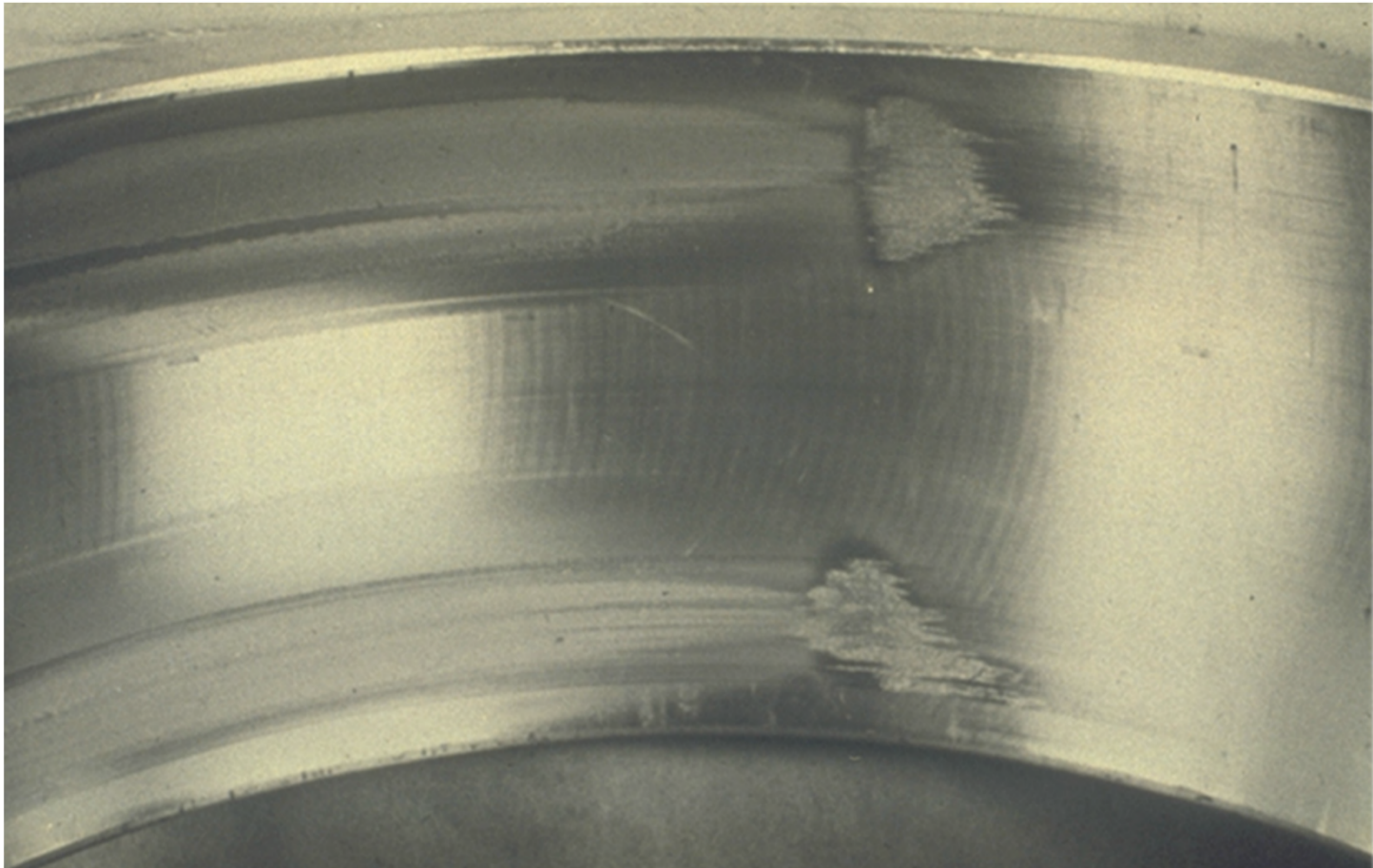



Inadequate Lubrication

Symptoms:

- Dull roughened tracking patterns arise from poor lubrication conditions. The thinner the lubricating film the greater the influence on the surface. When a specific load is high in the contact areas, the tracks are bright, pressure-polished and frequently shiny and are a clear contrast to the cycled part of the raceways.

Causes:

- Insufficient lubrication (type, quantity, etc.)
- The viscosity of the lubricant is insufficient for the operating temperature and speed

Possible Remedies:

- Improve lubricant supply
 - Change lubricant viscosity to suit operating conditions
 - Use approved lubricants with suitable additives
-

Contamination

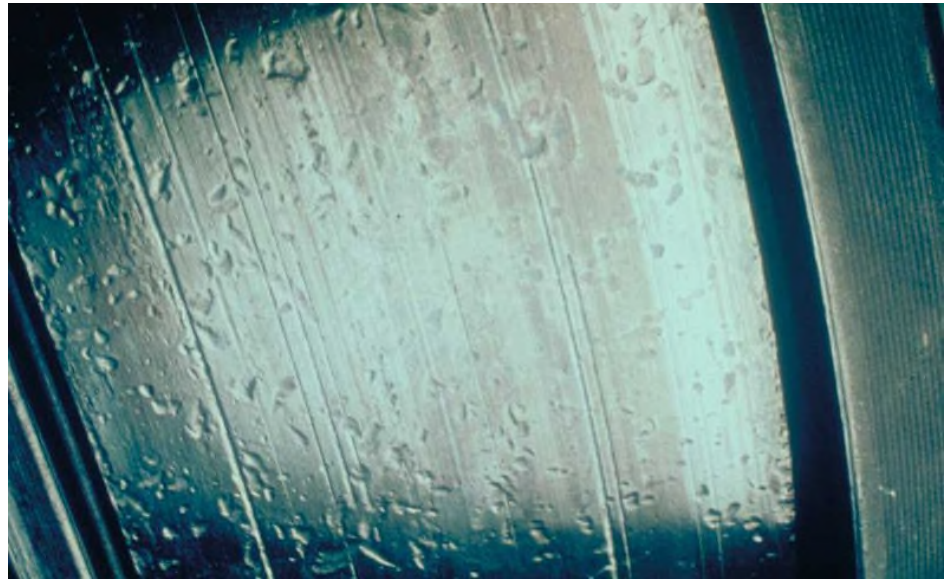
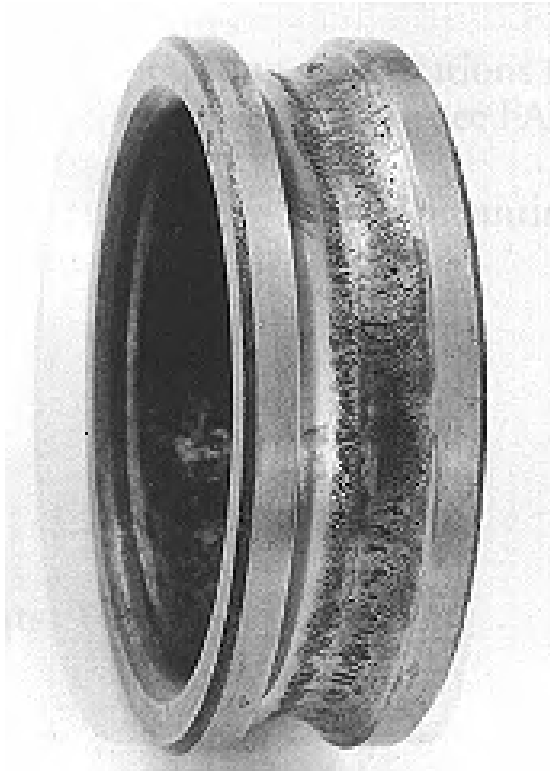



Contamination

Symptoms:

- Evidence of solid contamination:
- Indentations as a result of foreign particles being cycled on the raceway
- Fatigue resulting from the cycling of foreign particles
- Evidence of liquid contamination:
- Water can be taken up in small amounts by the lubricant – degrades the effect of lubrication
- In case of large amounts of moisture in the bearing dull tracks arise
- Pressure-polished tracks with fatigue damage results from corrosion or high load

Causes:

- Inadequate sealing
- Mounting conditions not clean
- Production residues, e.g. foundry sand
- Temperature differences (condensation of water)
- Dirty oil

Possible remedies:

- Improve sealing
- Clean mounting and well washed mating parts, coat if necessary
- Clean and flush the entire oil system before starting operation

Radial Preload

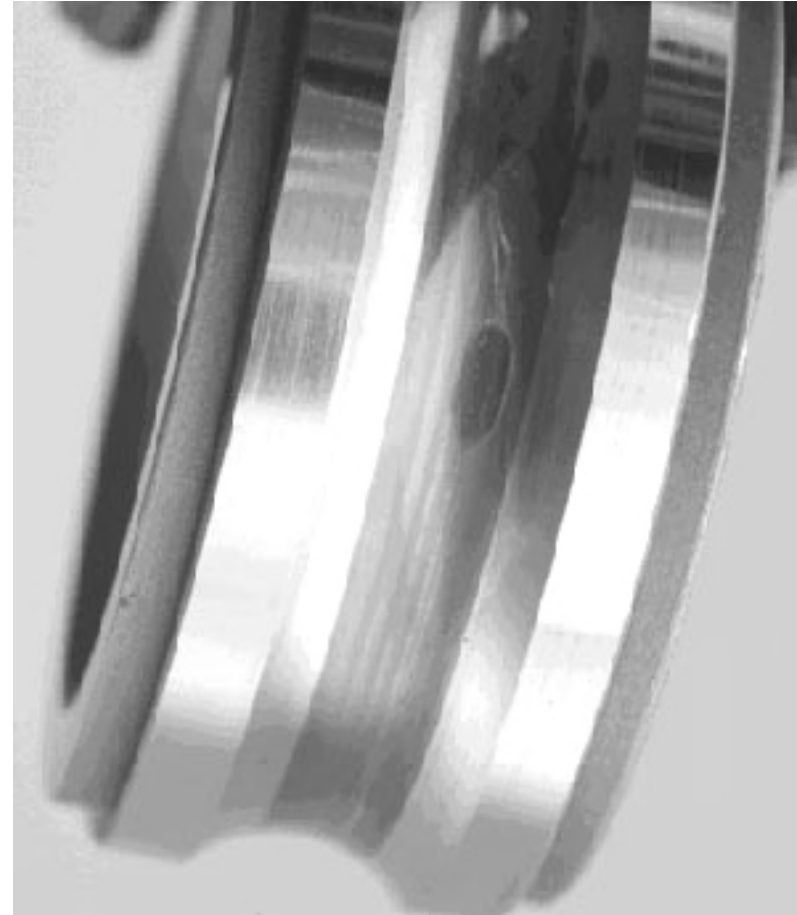
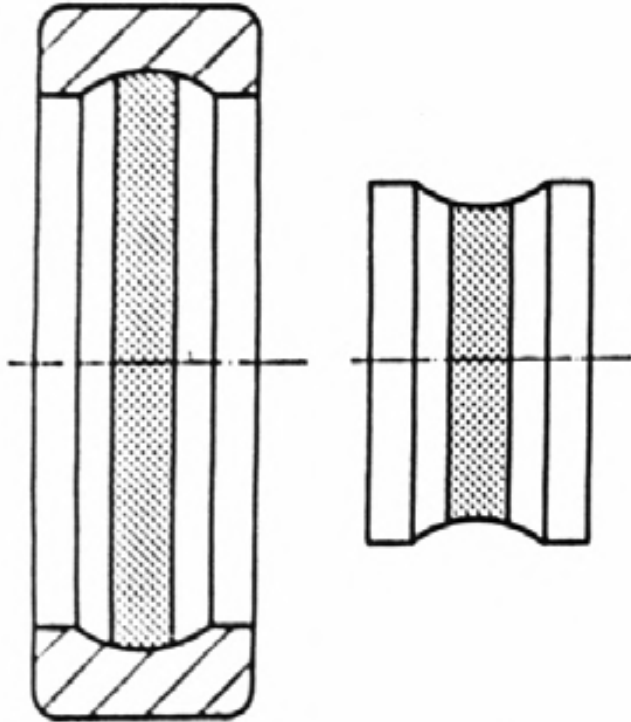



Radial Preload

Symptoms:

- Circumferential tracks appear on both rings in the case of detrimental radial preload.
- Running hot

Causes:

- Fit interference at shaft/ housing too large
- Excessive temperature difference between inner and outer ring
- Bearing clearance too small

Possible remedies:

- Check fit and form accuracy of mating parts
 - Change clearance to suit operating conditions
-

Out of Round

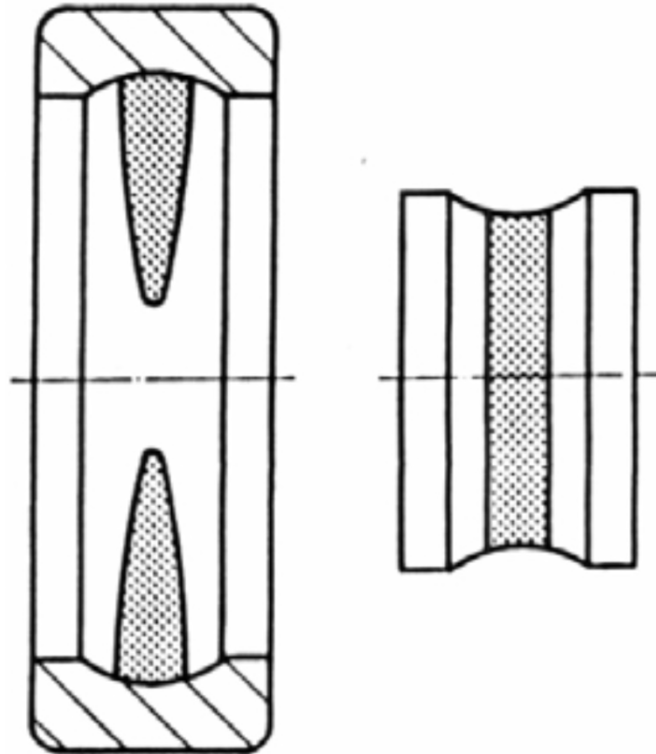



Out of Round

Symptoms:

- Separate tracking patterns develop on the circumference of the stationary ring

Causes:

- Oval housing or shaft
- Poor housing rigidity and support or high interference fits on the outer ring
- Storing bearings in the vertical position

Possible remedies:

- Check fit and form accuracy of mating parts
 - Change assembly and operating conditions
 - Store bearings according to manufacturer's specification
-

Axial Preload

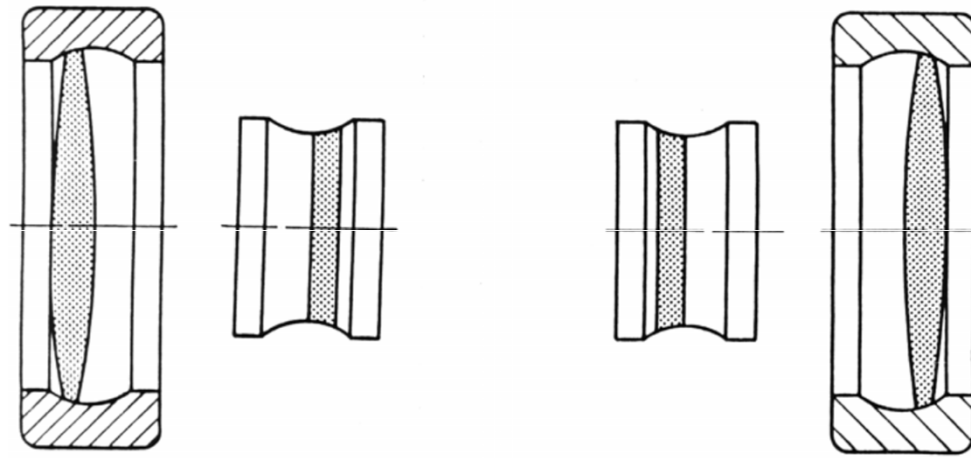



Axial Preload

Symptoms:

- Only the locating bearing of a locating-floating bearing arrangement may have distinctive tracks.
- At the most, a slight axial load share should be detected on the floating bearing.

Causes:

- Disturbed floating bearing function (wrong fit, radial-acting heat expansion, tilting, fretting corrosion)
- Unexpectedly high axial loading

Possible remedies:

- Check fits and form accuracy of mating parts
 - Change assembly and operating conditions
 - Use cylindrical roller bearing N, NU, NJ to allow linear expansion of the shaft when permissible.
-

Misalignment - 1

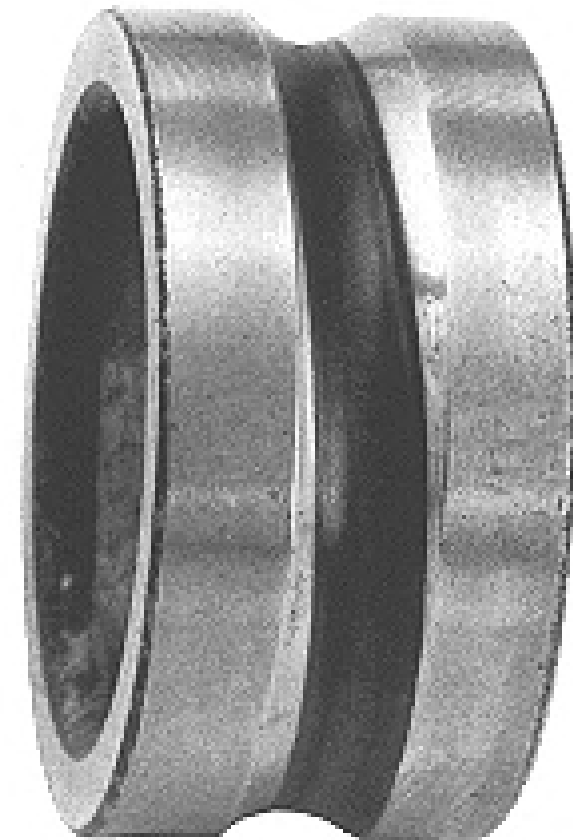
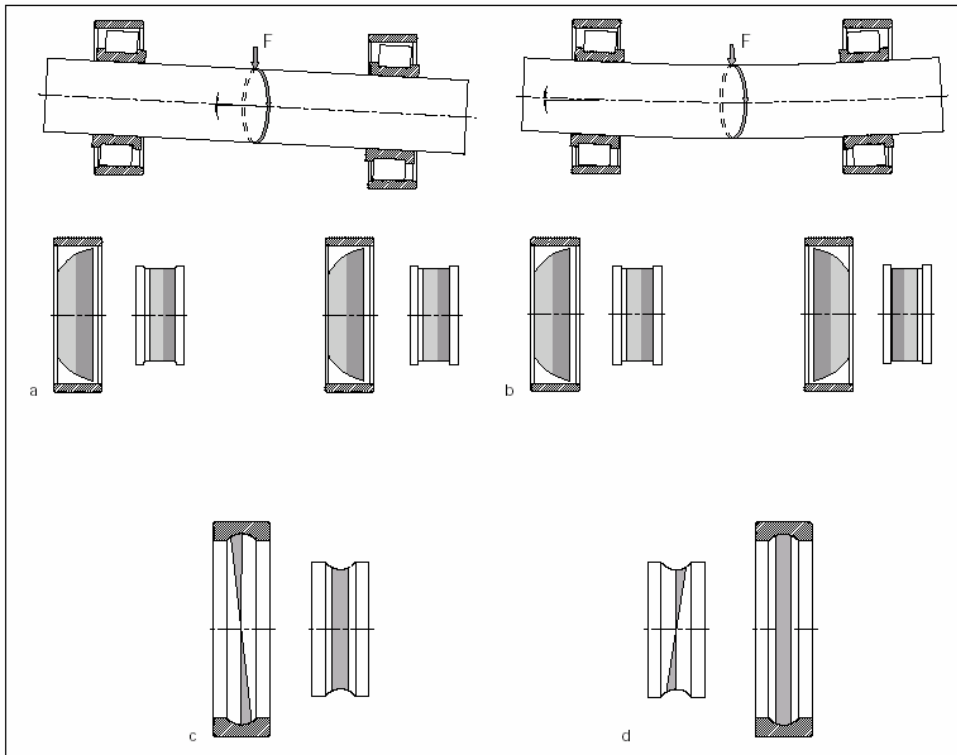



Misalignment - 1

Symptoms:

- Tracking pattern of the stationary ring does not run parallel with the raceway

Causes:

- Shaft deflection
- Poorly aligned housing halves or plummer block housings
- Out-of-square abutment surfaces
- Dirt between abutment surfaces and bearing rings during mounting
- Bearing clearance is too high in combination with moment load

Possible remedies:

- Observe mounting specifications regarding permissible tilting
 - Ensure cleanliness during mounting
 - Set suitable bearing clearance
-

Misalignment - 2

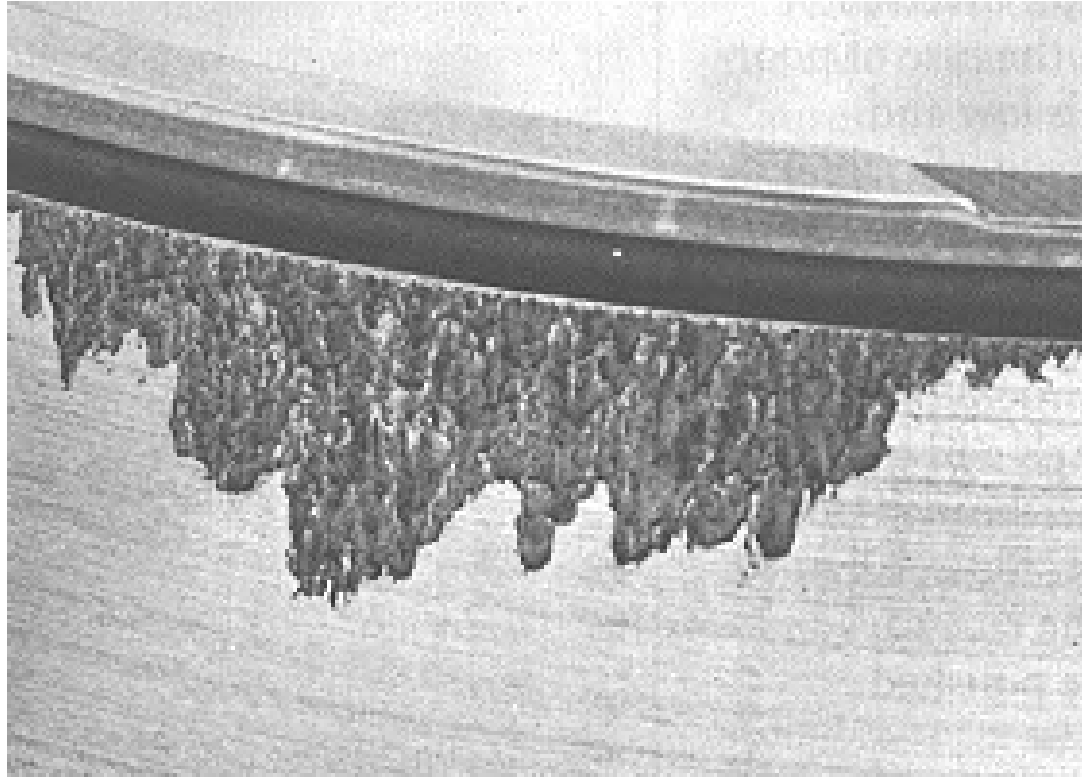



Misalignment - 2

Symptoms:

- Material flaking (relatively deep)
- Tracking asymmetric to bearing center
- Fatigue damage on the edges of raceway and/ or rolling elements

Causes:

- Misalignment of the housing or shaft, bending or tilting loads
- Balls running on the shoulder edge

Possible remedies:

- Use self-aligning bearings
 - Correct misalignment
 - Strengthen shaft
-

Improper Lubrication





Improper Lubrication

Symptoms:

- Diverse damage patterns arise
- Tiny superficial fractures and pitting develops

Causes:

- Poor lubrication condition as a result of insufficient lubricant supply
- Operating temperature too high
- Water penetration
- Very low or high loads on the raceways
- Slippage at times

Possible remedies:

- Increase lubricant quantity
 - Use lubricant with a higher viscosity, if possible with Extreme Pressure (EP) additives
 - Cool lubricant or bearing position
 - Use softer grease
 - Prevent water penetration
-

Corrosion

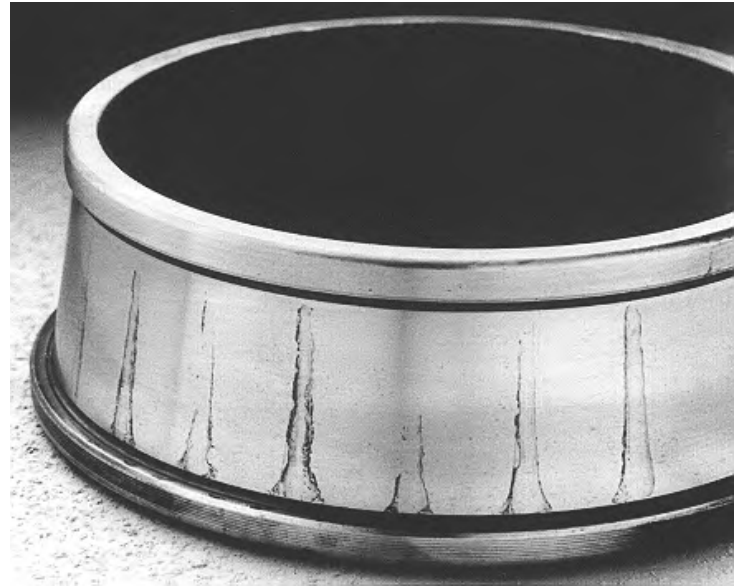
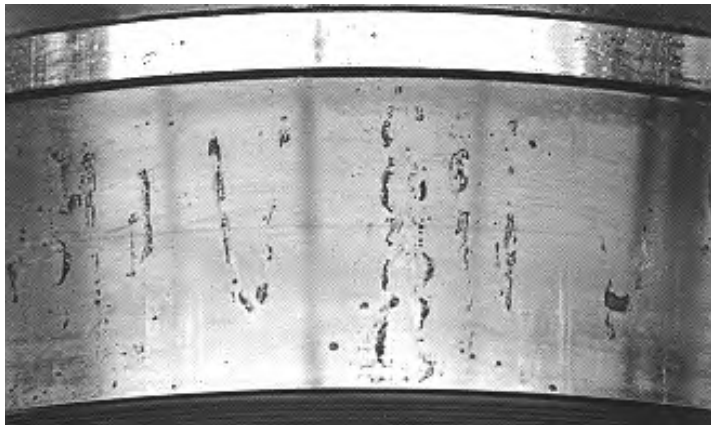



Corrosion

Symptoms:

- Brownish discoloration of the complete bearing surface, usually unevenly distributed in the form of individual pits
- Spots of rust with pits
- Wear at a later stage and premature fatigue originating at the rust pits

Causes:

- Inadequate sealing against moisture
- Acid fumes
- Lubricants containing acids
- Condensation
- Unsuitable storage of the bearings in the warehouse

Possible remedies:

- Suitable storage according to the specifications of bearing manufacturer
 - Improvement in seals (possibly additional shields)
 - Use lubricant with corrosion inhibitors
 - Re-lubricate frequently in the case of grease lubrication, particularly prior to standstill periods
-

Brinelling





Brinelling

Symptoms:

- Indentations or dents at the ball or roller spacing
- Surface texture remains at bottom of indentation

Causes:

- Improper mounting during installation
- Supporting an excessive static load
- Contamination with debris

Possible remedies:

- Follow proper bearing mounting procedure
 - Avoid excessive static loading
 - Filter oil
 - Use clean oil
-

False Brinelling

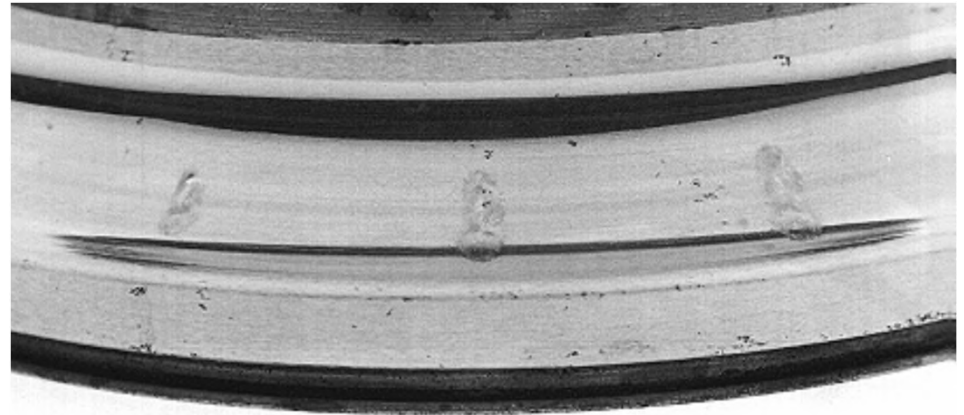
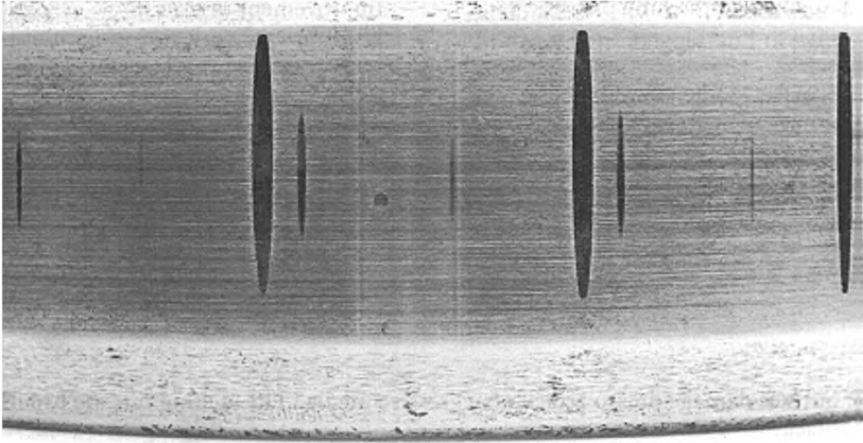



False Brinelling

Symptoms:

- Shiny marks and recesses on the raceway surface at the rolling element pitch
- No raised edges as opposed to marks due to incorrect mounting
- Scratches in the axial direction

Causes:

- Vibrations in stationary machines – leads to micro-motion in the contact areas

Possible remedies:

- Eliminate or absorb vibrations
 - Use locking devices to prevent possible movement during transportation
 - Slowly rotate bearings and shaft when not in service
-

Electrical Discharge

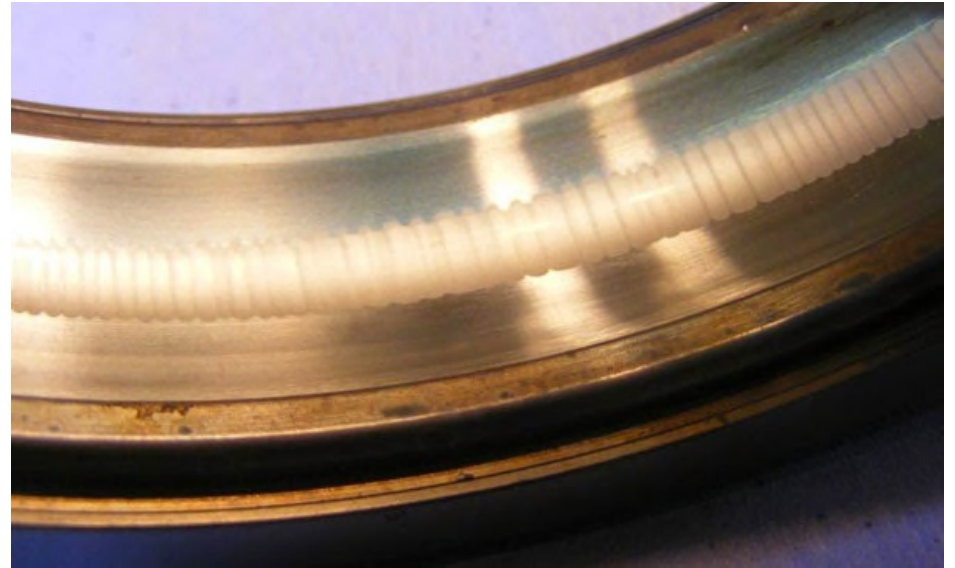



Electrical Discharge

Electrical Fluting

Symptoms:

- Brownish marks parallel to the axis on a large part of the raceway or covering the entire raceway circumference

Causes:

- Constant passage of alternating or direct current, even low currents cause marks

Possible remedies:

- Prevent currents from flowing through the bearing (grounding, insulation)
- Use current insulated bearings

Fusion Crater

Symptoms:

- The surface in the fusion craters is partly formed like welding beads.

Causes:

- Welding or poor ground contact

Possible remedies:

- Do not direct current through bearing during arc welding
 - Attached additional ground connections
-

Ring Fractures

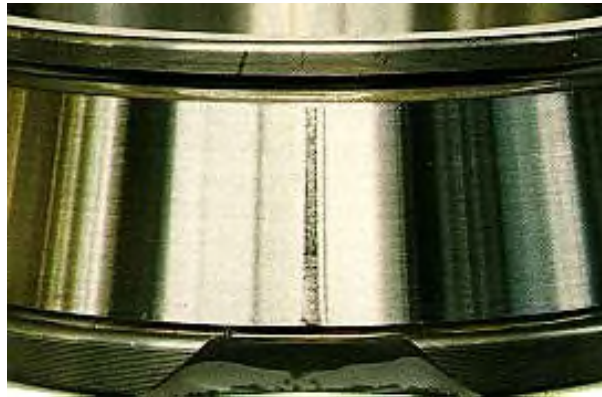
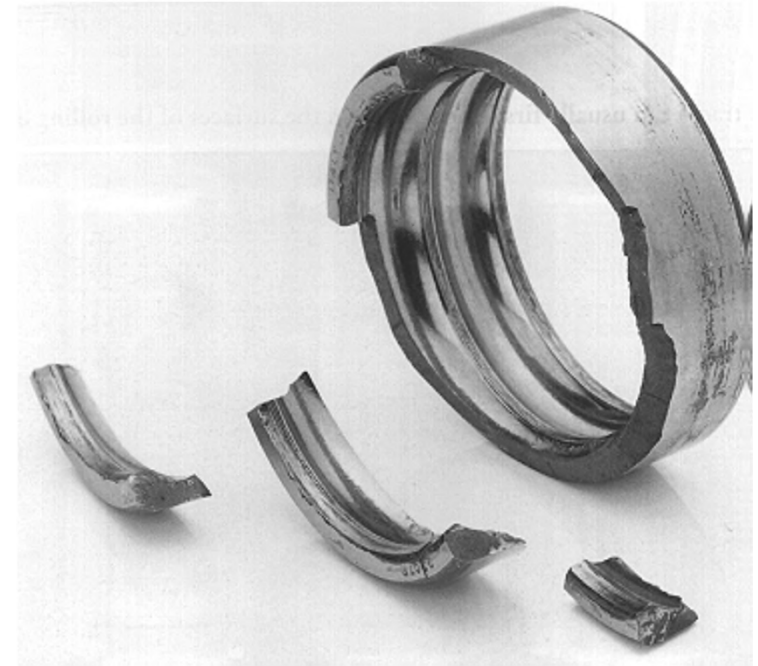

Ring Fractures - 1

Axial cracks and completely cracked inner rings

Symptoms:

- Ring partly or completely cracked in the axial direction
- In case of long term operation the edges of the cracks may be broken off

Causes:

- Bearing slippage
- Fractures in the raceway
- Rotation of inner ring on the shaft
- Unsuitable lubrication
- Fit too tight on the shaft
- Keyway or grooves in load zone
- Out-of-roundness

Possible remedies:

- Improve lubrication (additives, increase oil quantity)
- Find remedial measures for damage to raceway
- Select suitable fit
- Provide better seating conditions for the bearing (fits and surface finish)
- Special heat treatment for rings (case hardening)

Ring Fractures - 2

Outer ring fractures in circumferential direction

Symptoms:

- Cracks evenly in the circumferential direction
- With axial load, the fractures typically occur beyond the middle of the raceway
- Fatigue damage

Causes:

- Poor support of the rings in the housing

Possible remedies:

- Improvement in mounting required

Inner ring fractured lip

Symptoms:

- Lip fractured

Causes:

- Unsuitable design
- Inaccurate machining
- High axial loading

Possible remedies:

- Change mating parts construction

Overheating





Overheating

Symptoms:

- Bearing parts badly discolored (brown and blue shades due to extremely high operating temperatures)
- Deformed to a large extent

Causes:

- Bearing clearance in operating condition too low, especially with high speed bearings
- Inadequate lubrication
- Radial preload due to external heating
- Over-lubrication
- Impeded running due to cage fracture

Possible remedies:

- Increase bearing clearance
 - In case of external heating, increase heating times and cooling down time, to allow uniform heat distribution of complete bearing assembly
 - Avoid excessive lubricant build-up
 - Improve lubrication
-

Cage Damage

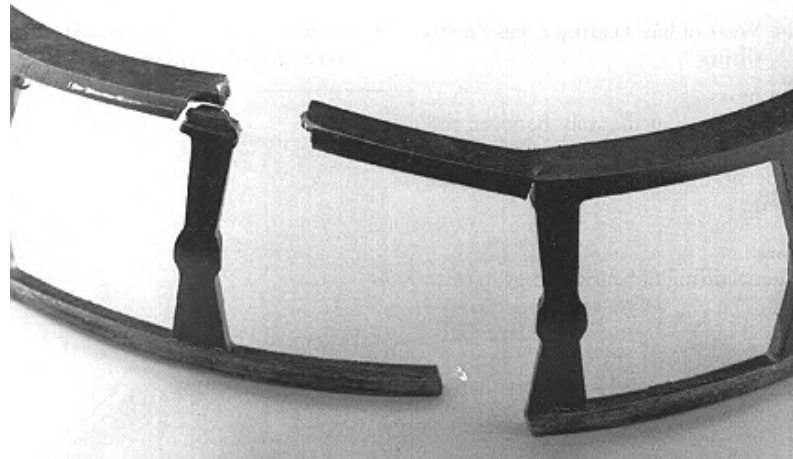
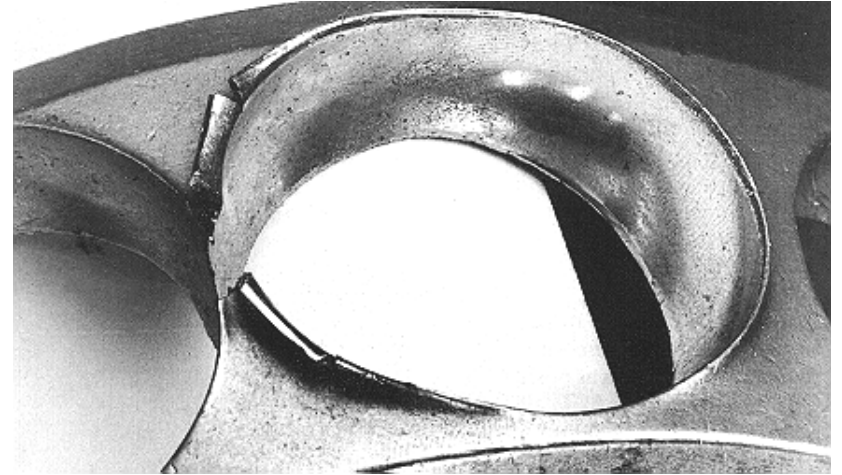



Cage Damage - 1

Cage wear due to starved lubrication and contamination

Symptoms:

- Wear in the pockets
- Poor rolling element guidance due to wear

Causes:

- Lubricant contaminated with hard foreign particles
- Too little or unsuitable lubricant

Possible remedies:

- Ensure clean assembly conditions
- Filter lubricant
- Increase lubricant flow through and/or apply a different viscosity

Cage wear due to excess speed

Symptoms:

- Excessive wear between the guidance surfaces of the cage

Causes:

- Excess speed
- Unsuitable cage construction selected

Possible remedies:

- Use different type of cage



Cage Damage - 2

Wear in ball bearing cages due to tilting

Symptoms:

- Deformation or fracture of the cage

Causes:

- Excess misalignment of the bearing rings to one another
- High acceleration forces
- Stress in cage area high, especially with poor lubrication

Possible remedies:

- Avoid tilting as much as possible
- Select self-aligning bearings or bearings with polyamide cages
- Special design: long hole pockets

Damage due to incorrect mounting

Symptoms:

- Broken, melted, cracked plastic cages and bent or warped metal cages

Causes:

- Incorrect heating of the bearing for mounting
- Unsuitable mounting tools

Possible remedies:

- Mount according to manufacturer's specifications



Cage Damage - 3

Cage fracture

Symptoms:

- Fracture of cage side edges, crosspiece fracture more seldom

Causes:

- Mounting damage
- Exceeded the permissible speed
- Poor lubrication
- Moment load too high or tilting of ball bearings
- Tapered roller bearing pairs with excessive clearance, or when axial loads reverse quickly

Possible remedies:

- Mount carefully
 - Filter lubricant
 - Increase lubricant flow through and/or different viscosity
 - Avoid misalignment or shaft deflection
 - Reduce bearing clearances
-



Gears

- Mild Wear
 - Moderate Wear
 - Abrasion
 - Polishing
 - Corrosion
 - Fretting Corrosion
 - Scaling
 - Cavitation
 - Erosion
 - Electrical Discharge
 - Scuffing
 - Indentation Damage
 - Plastic Deformation
 - Rippling
 - Ridging
 - Burr
 - Pitting
 - Spalling
 - Micropitting
 - Cracking
-

Mild and Moderate Wear

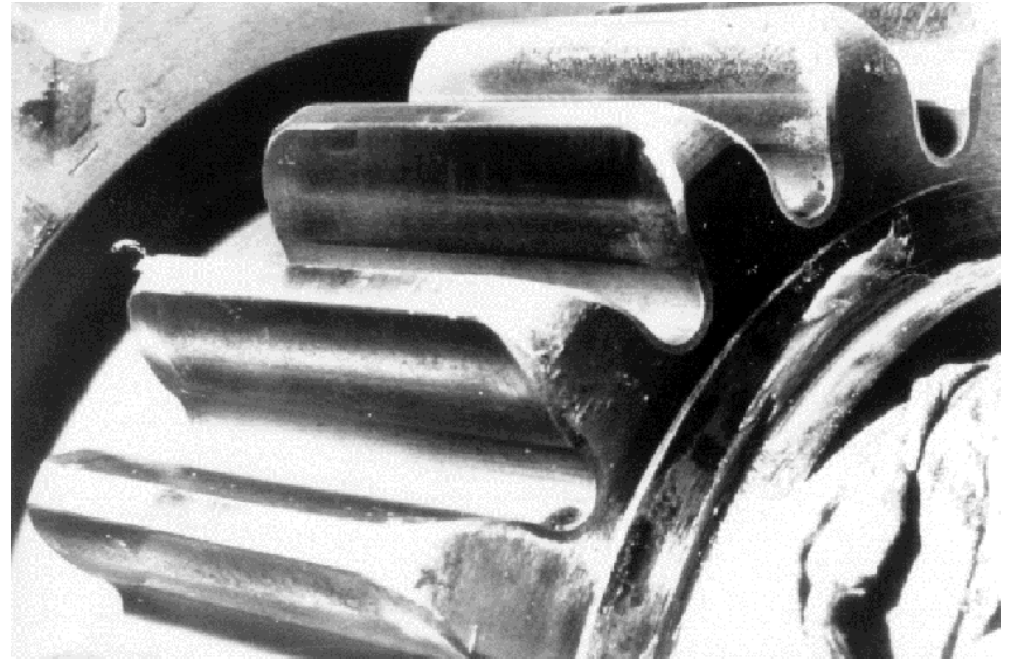
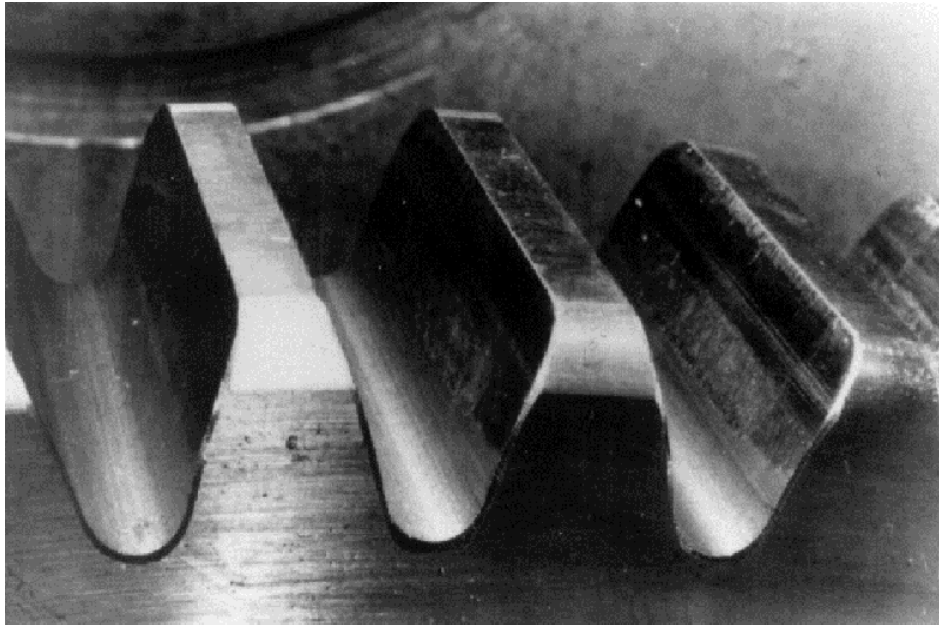

Abrasion

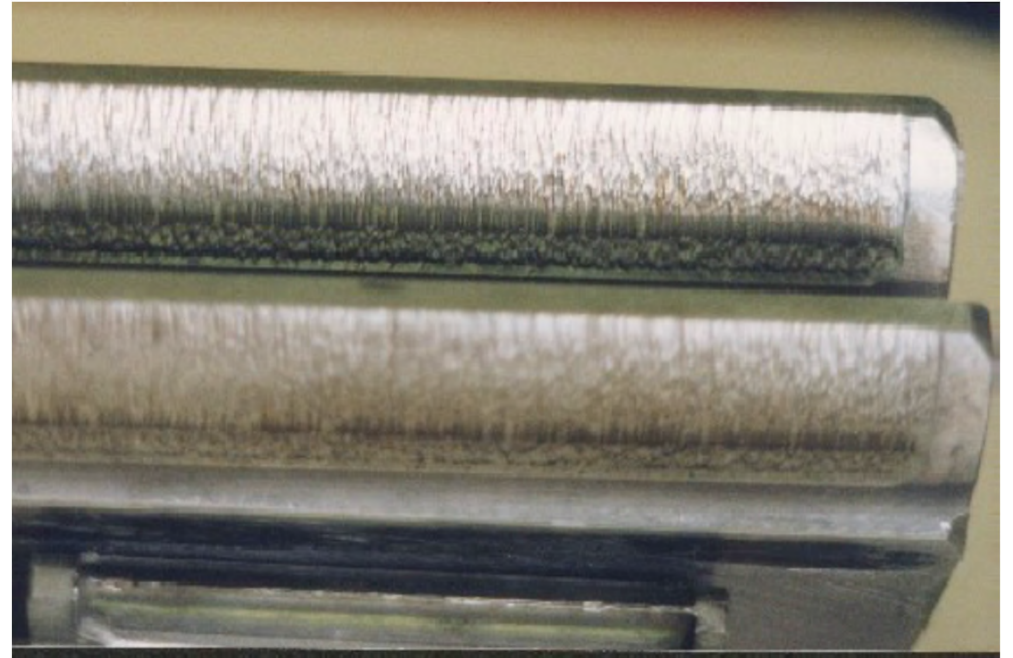
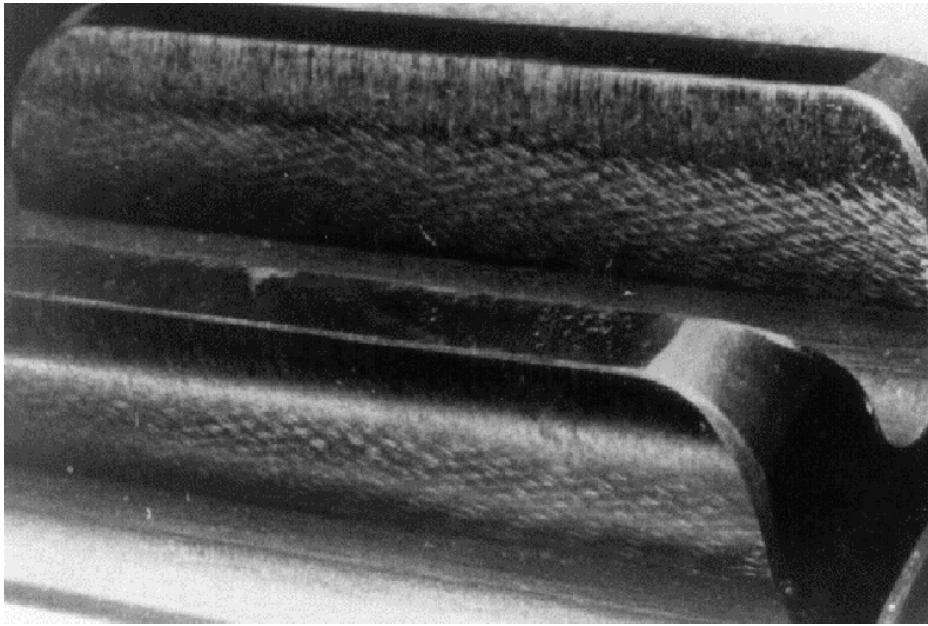

Polishing

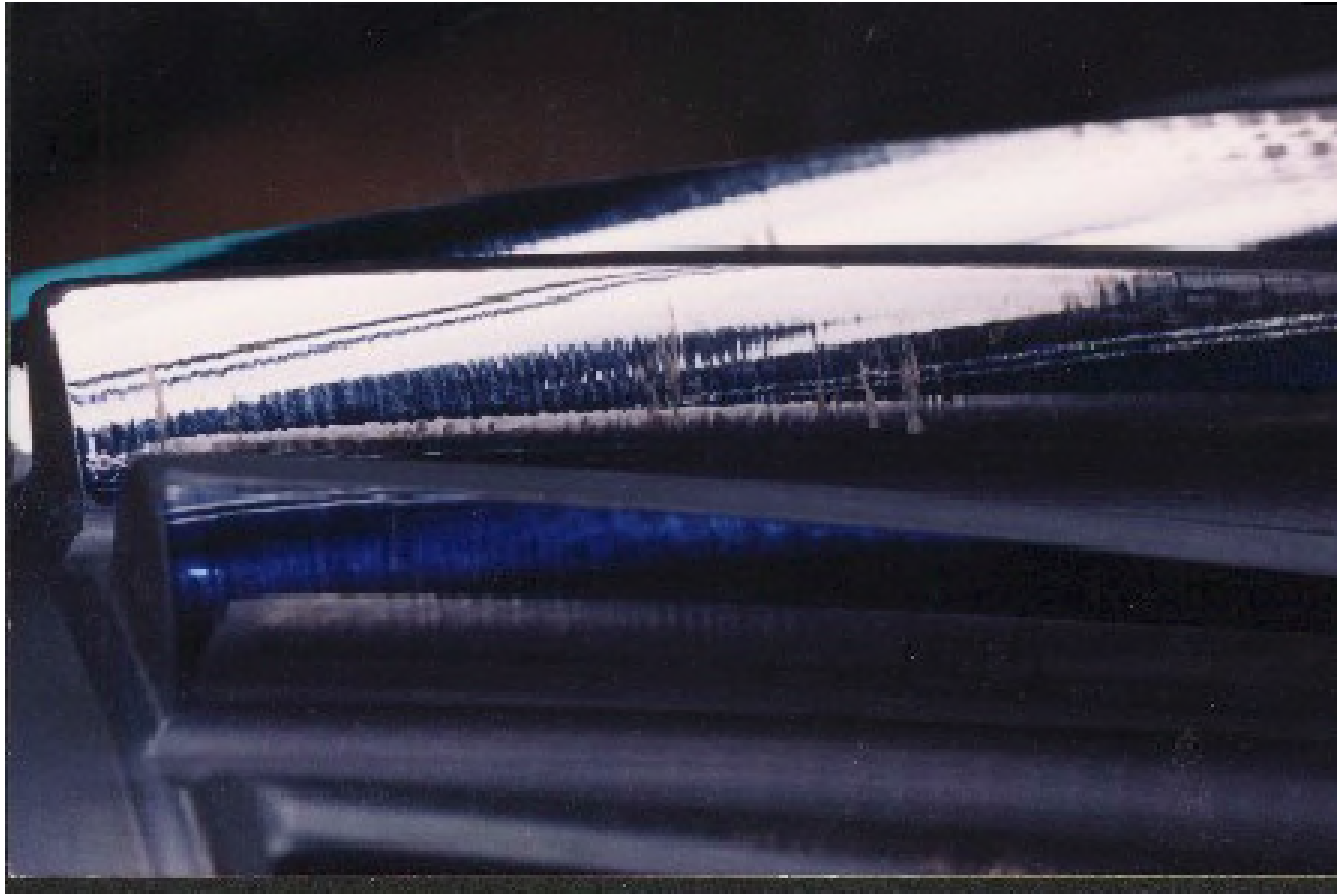

Corrosion

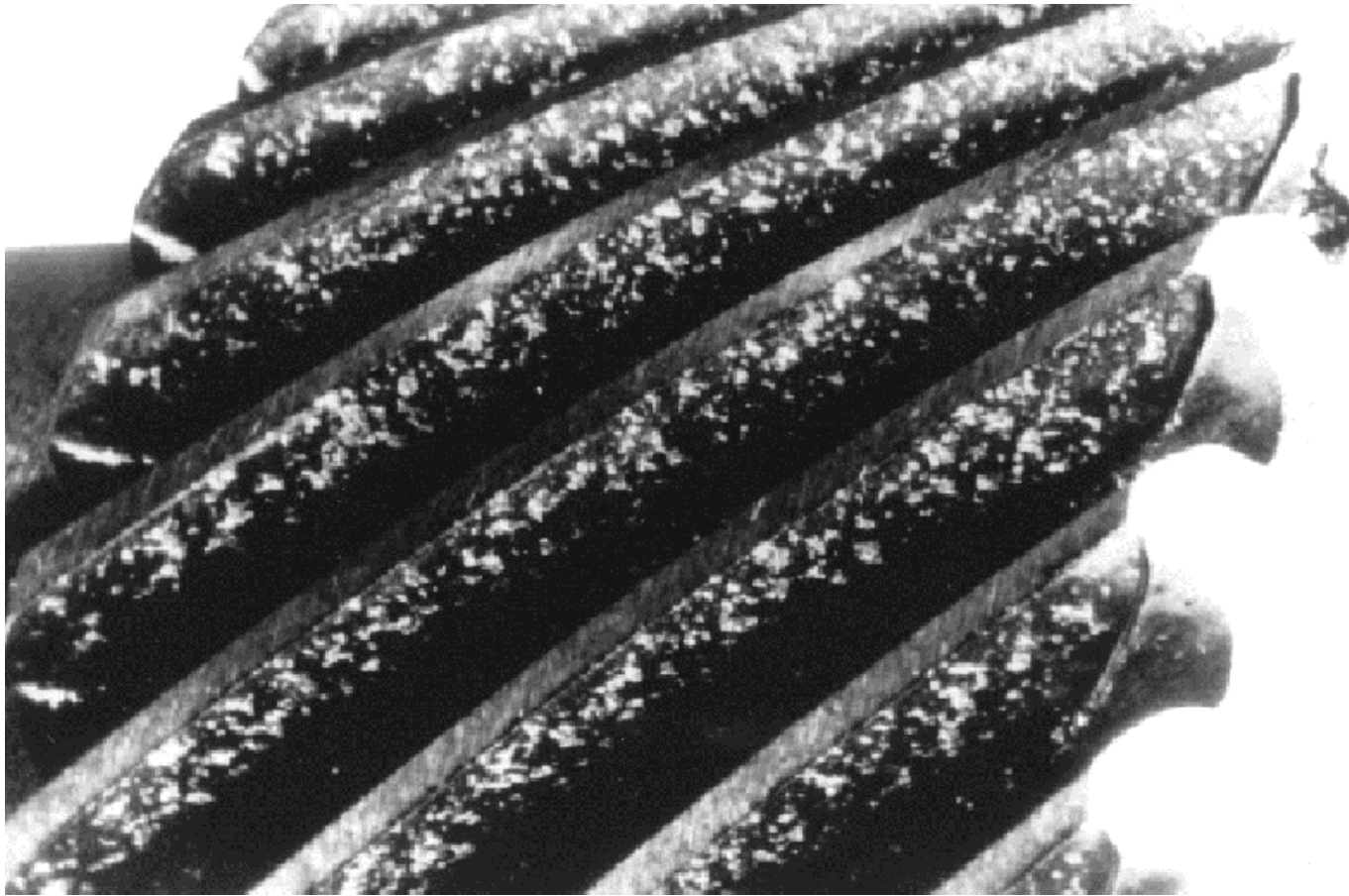

Fretting Corrosion



Scaling

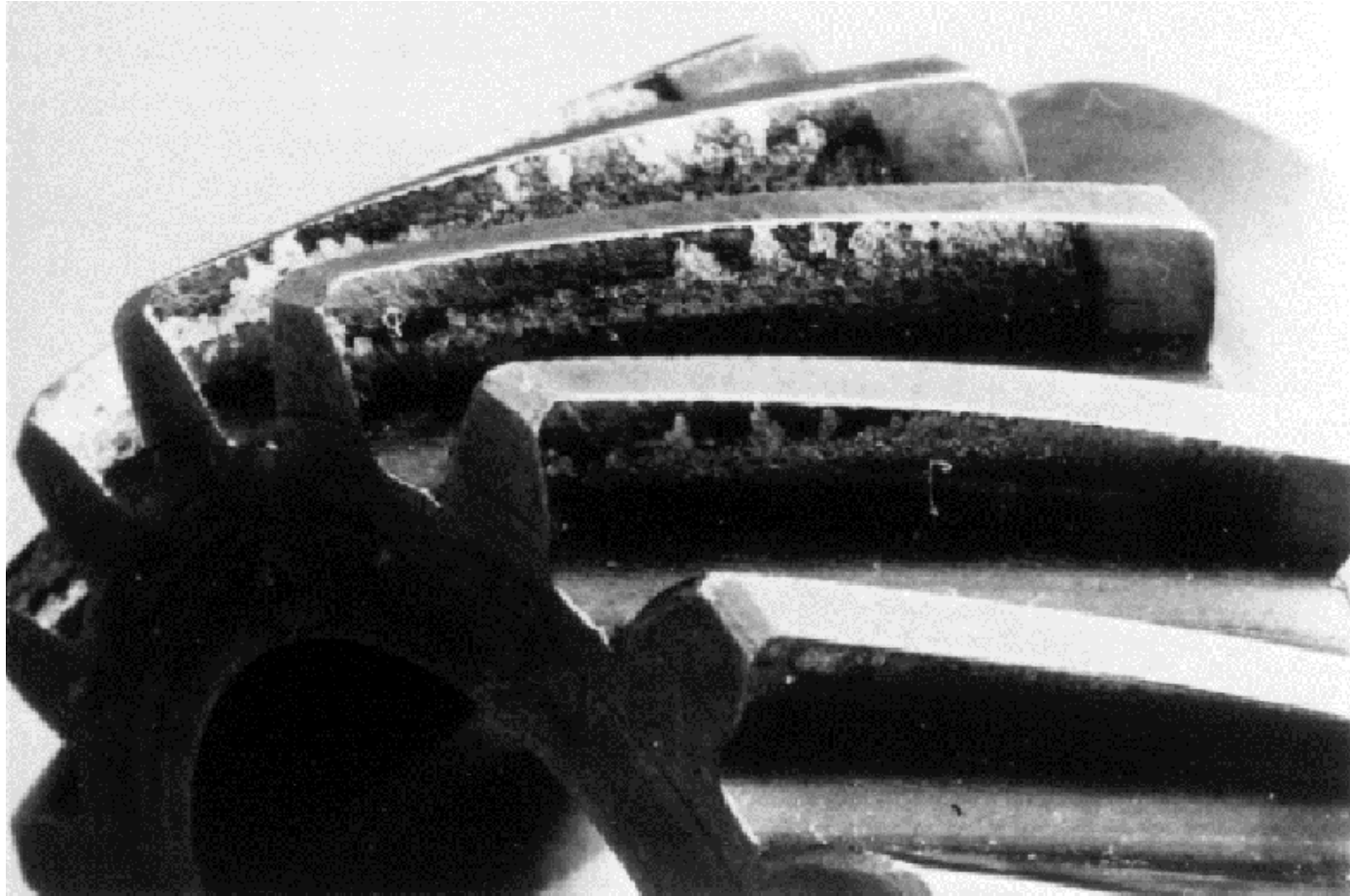

Cavitation

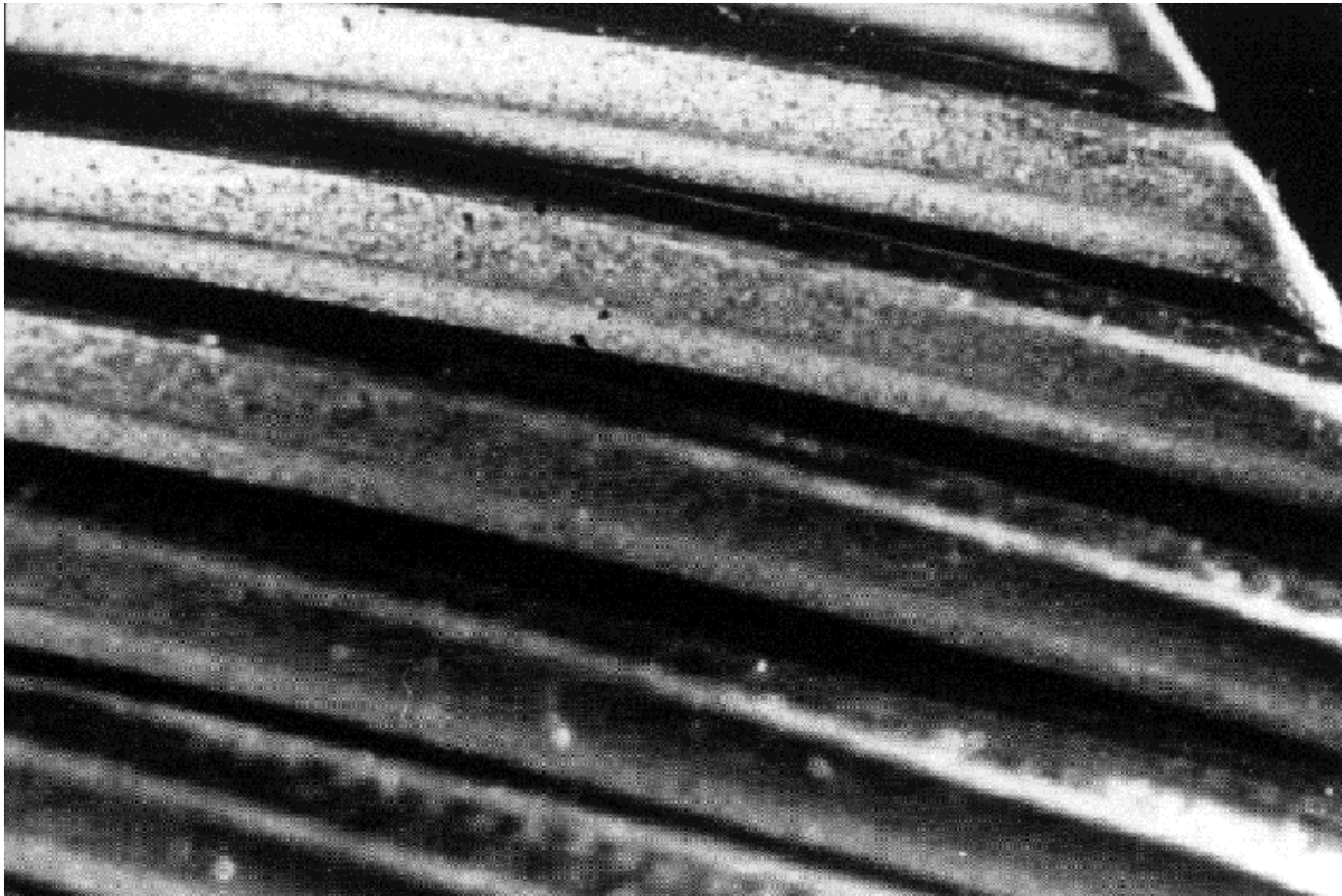

Erosion

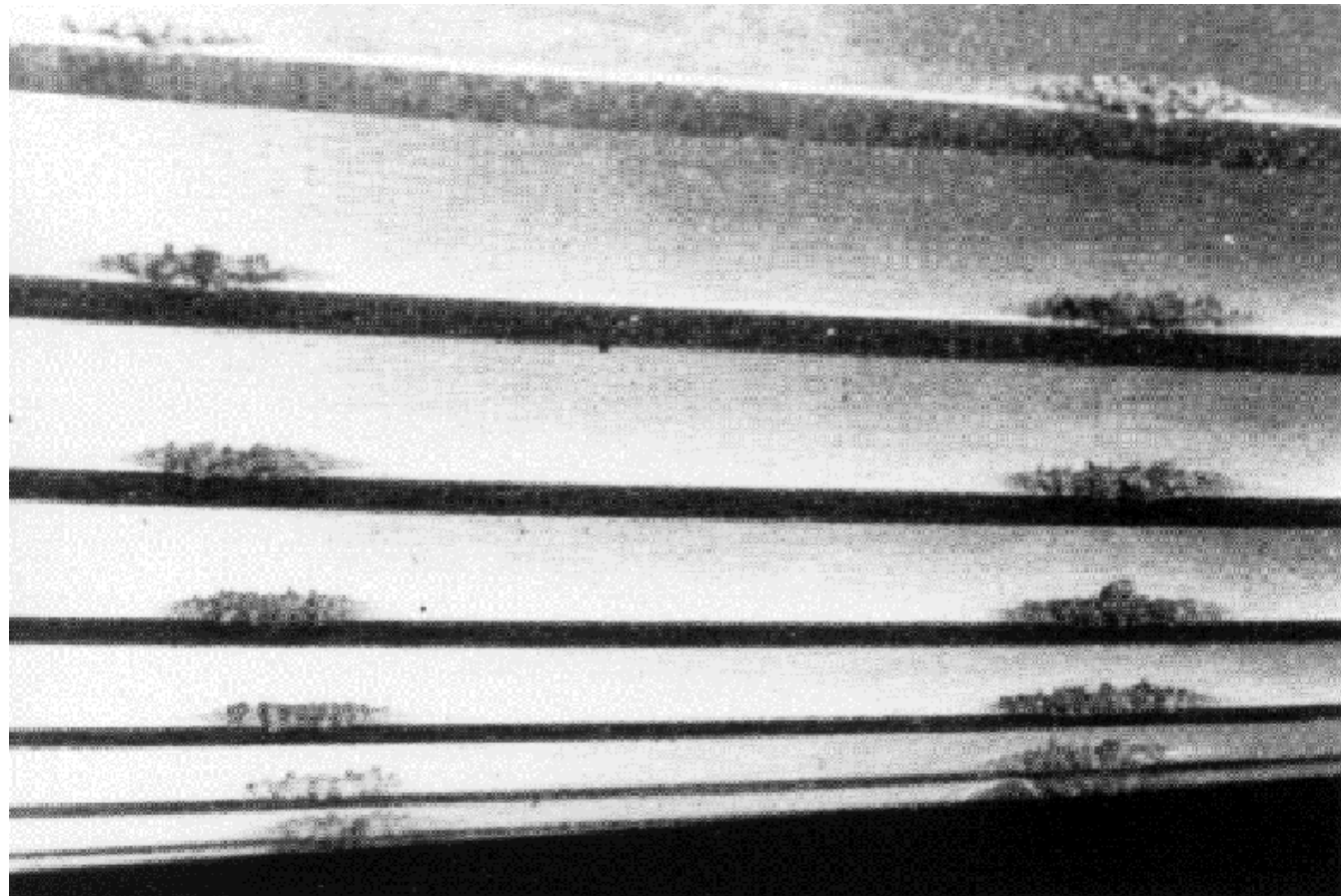

Electrical Discharge

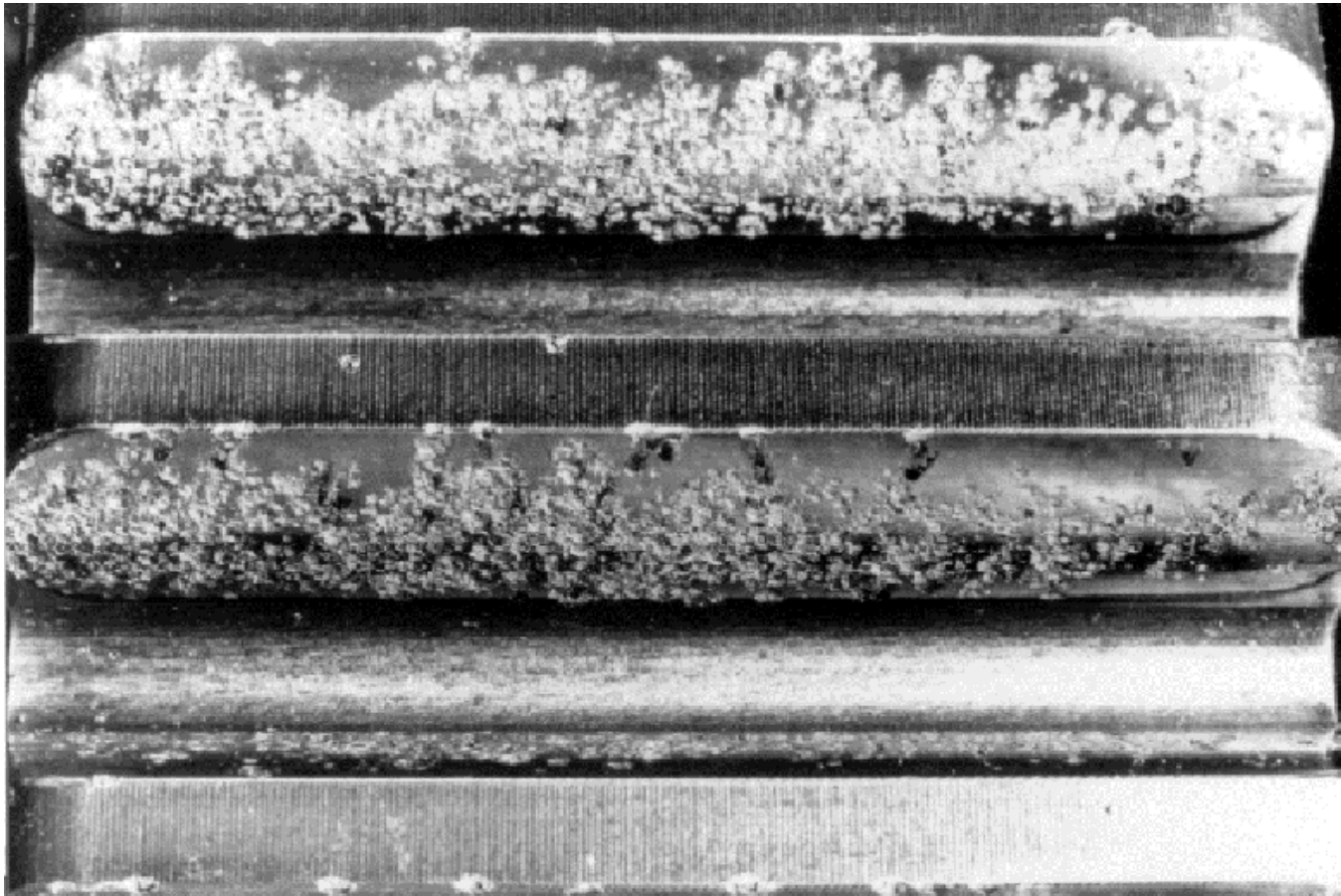

Scuffing

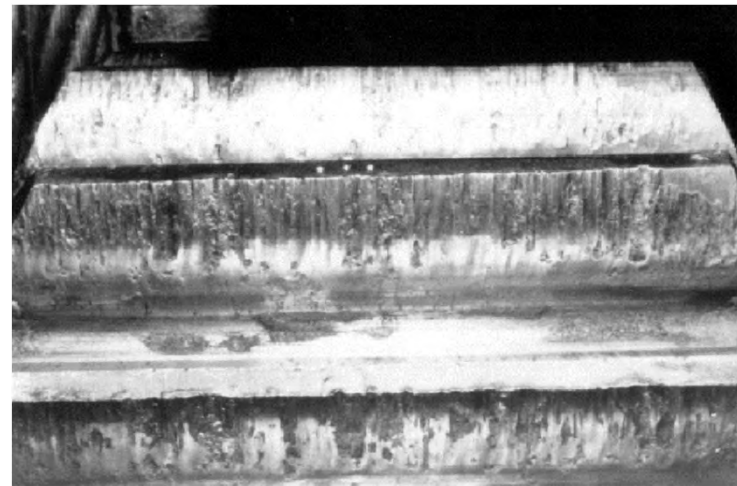
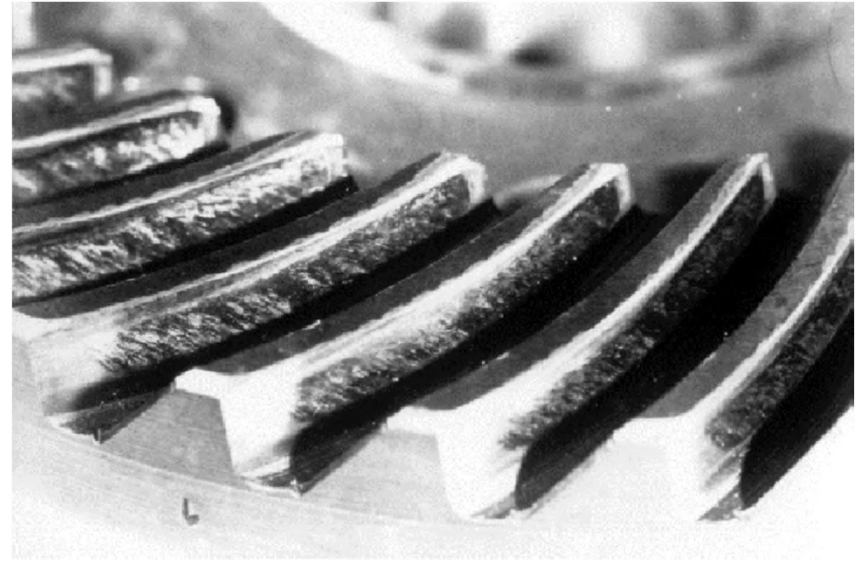
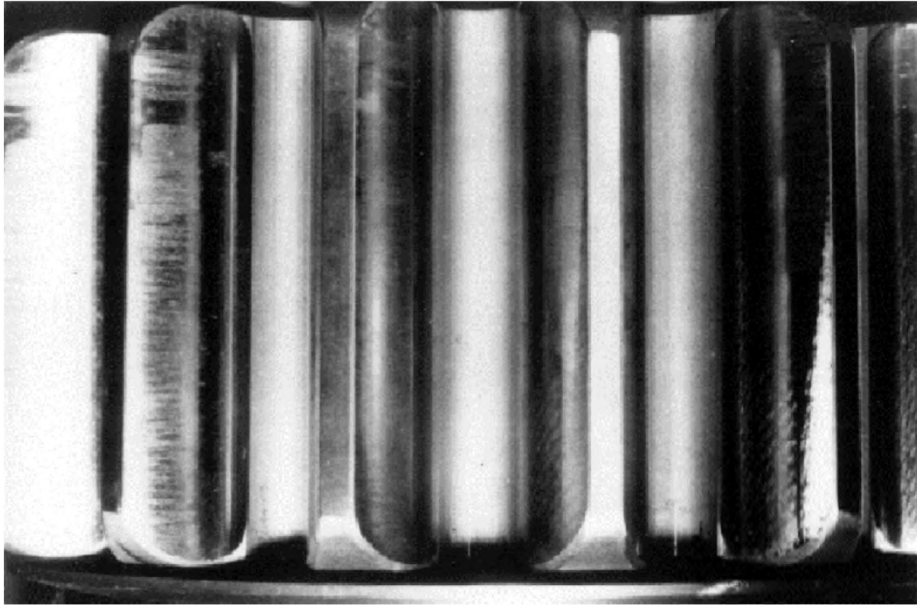

Indentation Damage



Plastic Deformation



Rippling

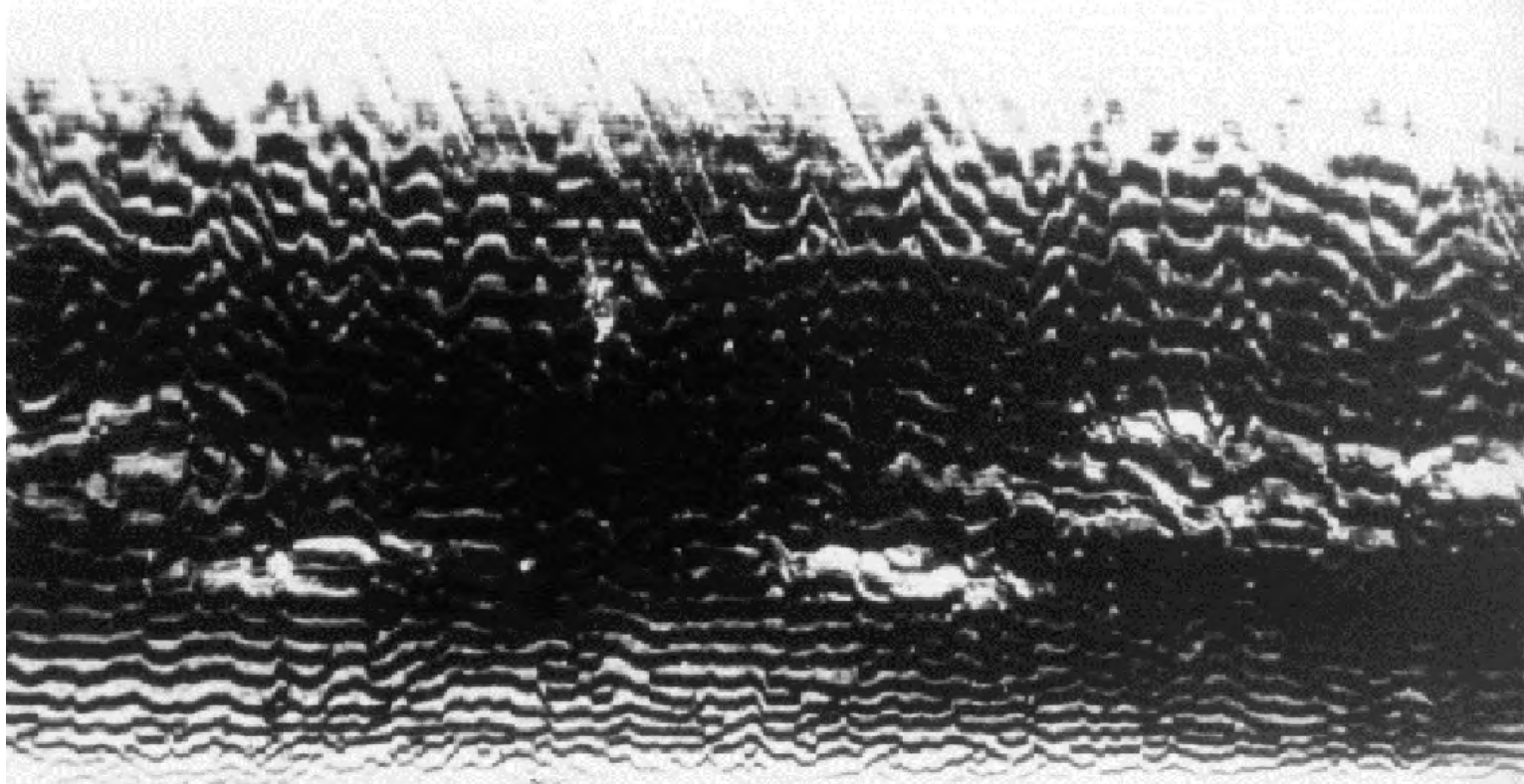

Ridging

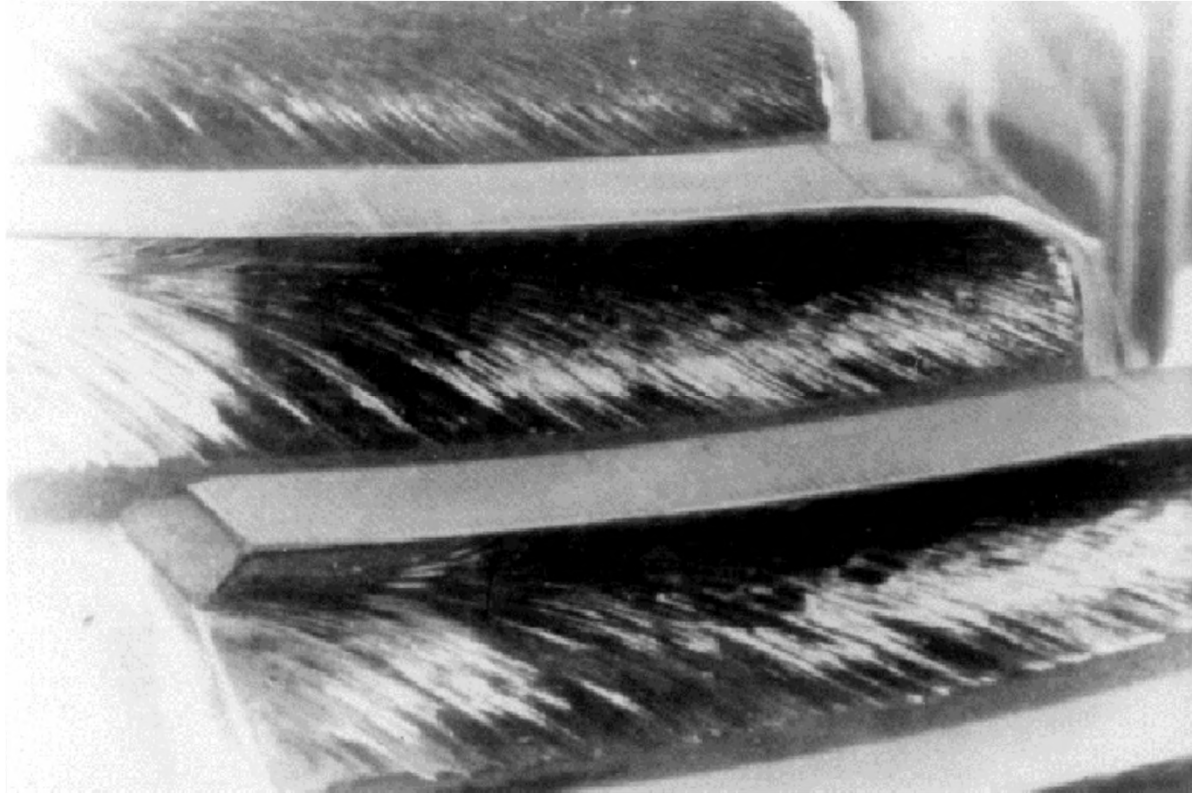

Burr



Pitting

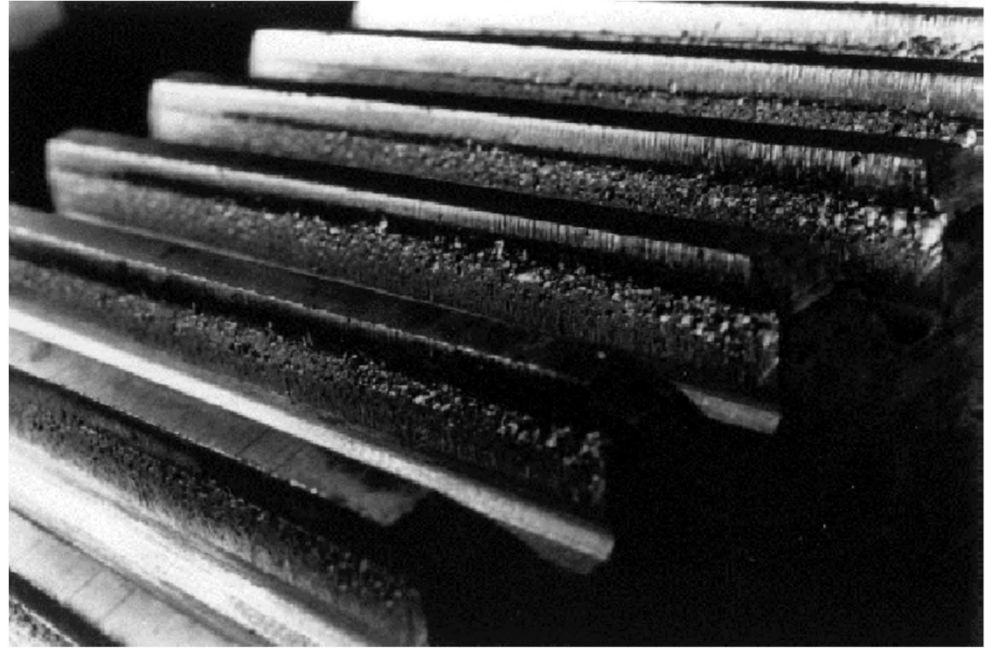
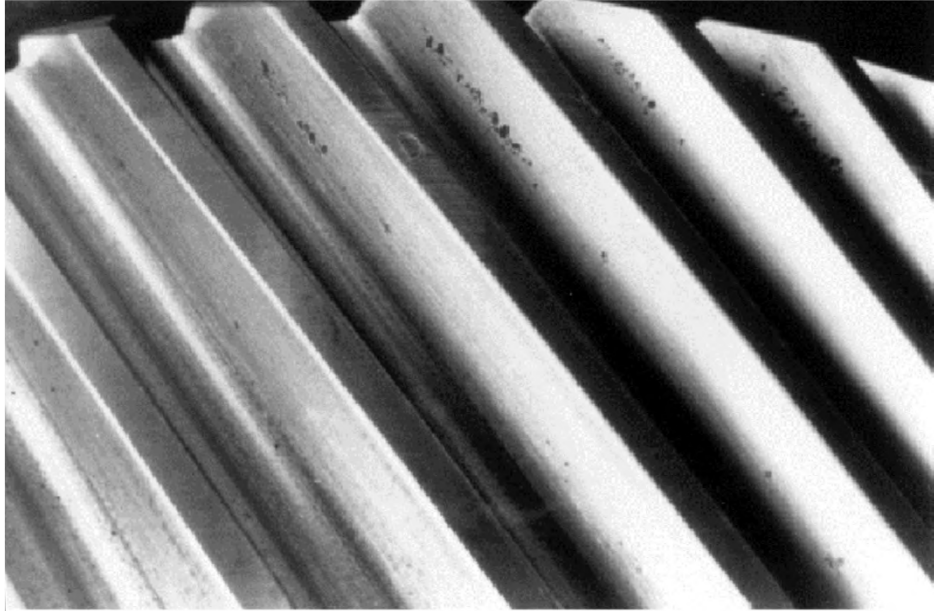

Spalling

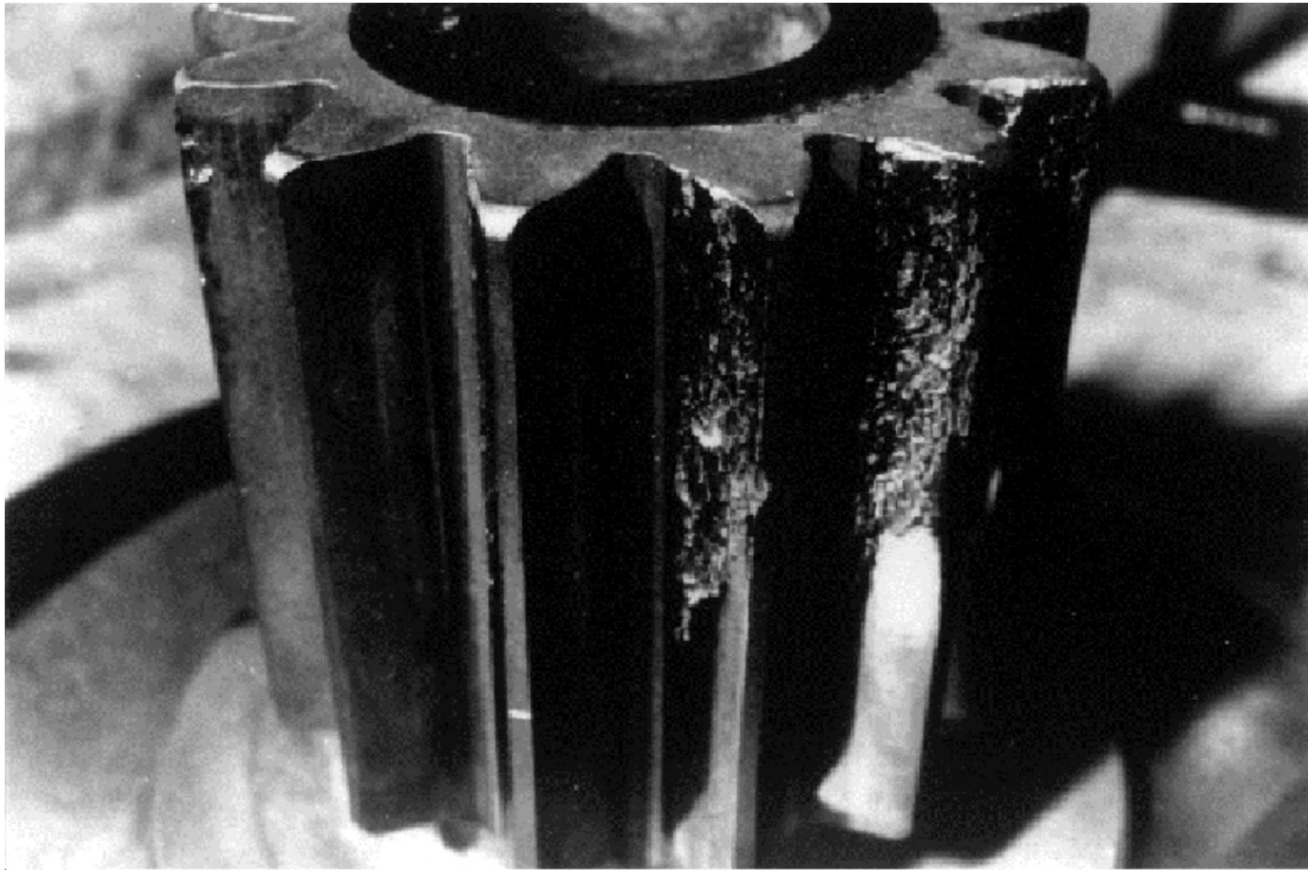

Micropitting

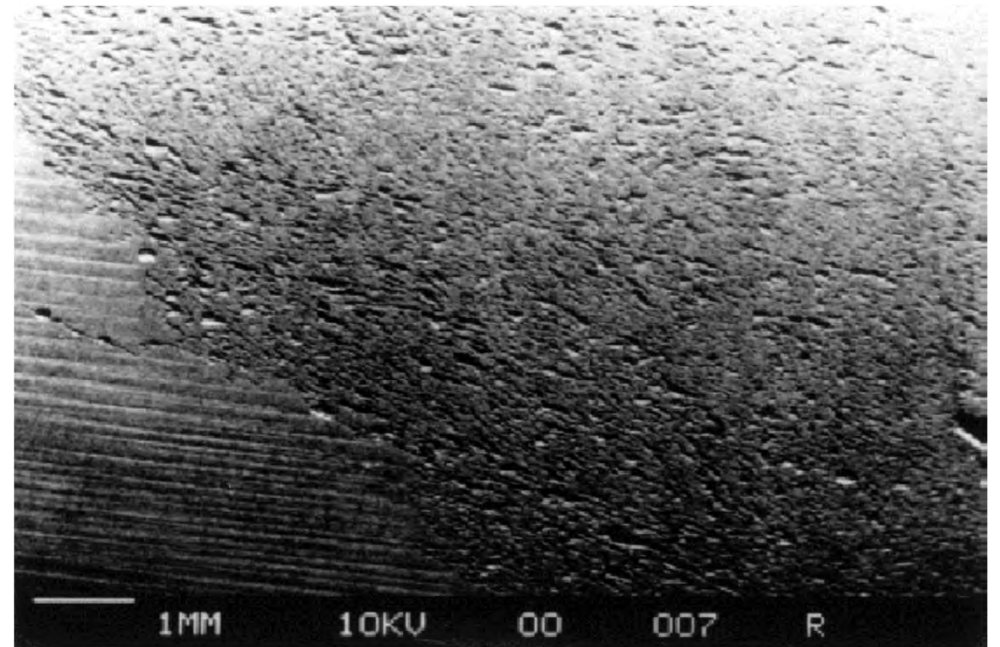

Cracking

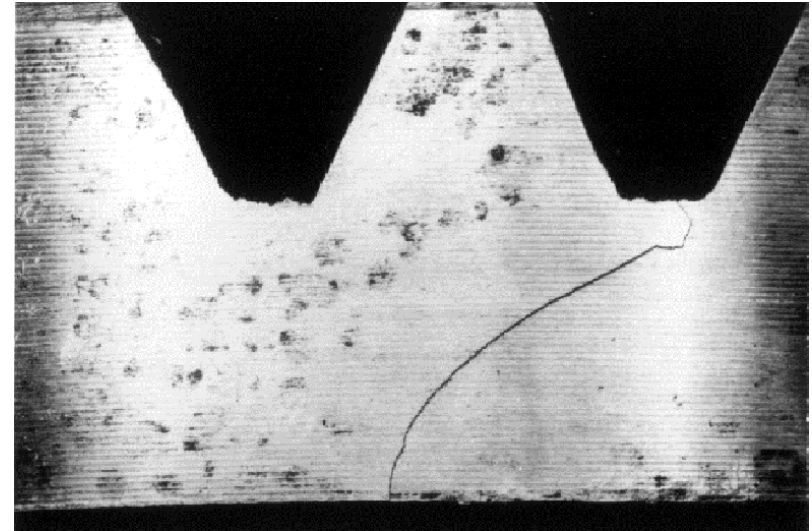
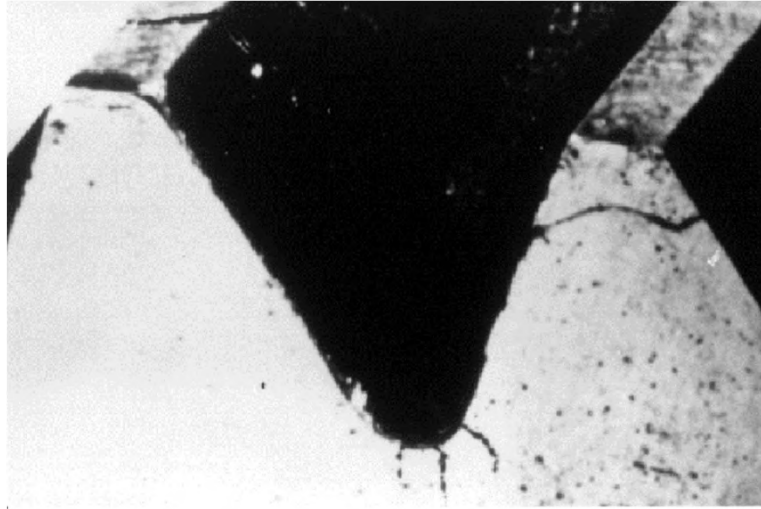



Questions

- Please post your questions using the Q&A function.
-



How to Contact Us

- Lubes Answer Line

800-248-4684

8:00 AM - 12:00 PM, 1:00 PM – 5:00 PM CT
Monday through Thursday

8:00 AM - 12:00 PM, 1:00 PM – 4:30 PM CT
Friday

lubeshelp@citgo.com



Future Webinars

August 6, 2021

Contaminants in Lubricants

August 20, 2021

Lubricants Technology Services

September 3, 2021

LubeAlert Oil Condition Monitoring

September 17, 2021

Sales to Heavy Duty Fleet Prospects
